

**Digital Satellite Receiver
Owner's Manual**

HUGHES
NETWORK SYSTEMS

Model: HIRD-D2

Trademarks and Copyrights—

Software contained in the digital satellite receiver and this manual is copyright © 1995, 1996, 1997, 1998 and 1999 by Hughes Network Systems. Some features are patent pending. WatchWord, PreSelect, TurboTune, and OneLine Guide are trademarks of Hughes Network Systems. DIRECTV and DIRECT TICKET are registered trademarks of DIRECTV, Inc. a unit of Hughes Electronics Corp., and are used with permission. USSB and USSB Entertainment are registered trademarks of United States Satellite Broadcasting Company, Inc. "NFL," the NFL Shield and "NFL SUNDAY TICKET" are registered trademarks of The National Football League and its affiliates. NBA LEAGUE PASS is a trademark of NBA Properties, Inc. NHL, the NHL Shield and NHL CENTER ICE are registered trademarks of the National Hockey League. ESPN Full Court and MLS/ESPN SHOOTOUT are trademarks of ESPN, Inc. "MLB," "MLB EXTRA INNINGS," "Major League Baseball" and the Major League Baseball silhouetted batter logo are service marks of Major League Baseball Properties, Inc. Major League Baseball trademarks and copyright are used with permission of Major League Baseball Properties, Inc. All other trademarks and service marks are the property of their respective owners.

This product is the subject of one or more U.S. or foreign patents pending.

Disclaimer—Every effort has been made to ensure the correctness and completeness of the material in this document. No company shall be liable for errors contained herein. The information in this document is subject to change without notice. No warranty of any kind is made with regard to this material, including, but not limited to, the implied warranties of merchantability and fitness for a particular purpose.

StarSight Information—StarSight® features licensed under one or more of the following U.S. patents: 4,706,121; 5,151,789; 5,335,277; 5,353,121; 5,479,266; 5,479,268; and 5,532,754. Use rights reserved.

Macrovision Information—This device incorporates an anticopy process technology that is protected by U.S. patents and other intellectual property rights. The anticopy process is licensed for noncommercial, home use only. Reverse engineering or disassembly is prohibited.

Note on Recording Programming—Most television programs and films are copyrighted. This means that someone has legal rights governing the reproduction and distribution of this material. In certain circumstances, copyright law may apply to private in-home taping of copyrighted materials. In most cases, it is permissible to record for personal use, as long as you do not sell the material. You must act responsibly in this area — check into the matter if you are unsure.

Some pay per view programs may be licensed from producers as "view only" programs. These are copyrighted programs and may not be copied or reproduced for any

purpose without the express written permission of the copyright owner.

DIRECTV System Programming—For subscription information, or to resolve problems related to DIRECTV System programming, call the service providers, including DIRECTV at 1-800-DIRECTV (347-3288) and USSB at 1-800-204-USSB (8772).

DIRECTV System Hardware and Installation—To arrange for professional installation of your DIRECTV System, ask questions, or to resolve problems related to your DIRECTV System, contact your dealer. If additional information is needed, please contact the Customer Care Center toll free at 1-800-274-8995.

Hughes Customer Care Center
1-800-274-8995
Subscriptions and PPV
1-800-DIRECTV or 1-800-204-USSB

**PLEASE MAKE NOTE OF THE
FOLLOWING INFORMATION FOR
WARRANTY**

System Model #: HSYS- D 2 5 _____

Receiver Model #: HIRD- D25

Receiver Serial #:

Access Card #: _____

LNB Serial #:

IMPORTANT SAFETY INSTRUCTIONS

For your safety and protection, read this entire Owner's Manual before you attempt to install or use your DIRECTV System. In particular, read this safety section carefully. Keep this safety information where you can refer to it if necessary.

INSTALLATION

Polarization—This DIRECTV System product is equipped with a plug that will fit into the power outlet only one way. Do not modify the plug defeating this feature. If the plug does not fit, contact your electrician to replace your outlet. To prevent electric shock, do not use this plug with an extension cord or outlet unless you can fully insert the blades without blade exposure.

Power Sources—Operate this DIRECTV System product only from the type of power source indicated on the marking label. If you are not sure of the type of power supply to your home, consult your DIRECTV System dealer or local power company.

Ventilation—Do not block the ventilation slots and openings in the case. Do not block these openings by placing the product on a bed, sofa, rug, or other similar surface. Do not place this product near or over a radiator or heat register, or in a built-in installation such as a bookcase or rack unless proper ventilation is provided.

For electrical safety, power line operated equipment or accessories connected to this unit should bear the UL listing mark or CSA certification mark and should not be modified so as to defeat the safety features. This will help avoid any potential hazard from electrical shock or fire. If in doubt, contact qualified service personnel.

Accessories—To avoid personal injury or damage to the digital satellite receiver, do not place the digital satellite receiver on any unstable cart, stand, table, or bracket. Any mounting of the product should follow the manufacturer's instructions.

Attachments—Do not use attachments unless recommended by the DIRECTV System product manufacturer as they may cause hazards.

Satellite Dish Antenna Grounding—The outdoor satellite dish antenna used to receive satellite signals and the cable used to connect the satellite dish antenna to the indoor receiving unit are required to comply with local installation codes and the appropriate sections of the National Electric Code (NEC) and in particular Article 810-15, which covers proper installation and grounding of television receiving equipment, as well as to Article 820-33, which specifies that the satellite dish antenna cable ground shall be connected to the grounding system of the building as close to the point of cable entry as practical. These codes require proper grounding of the metal structure of the outdoor satellite dish antenna and grounding of the connecting cable at a point where it enters the house (or other building). If you are having a professional installer

make the installation, the installer must observe installation codes. This manual contains instructions on how to make the installation in compliance with the NEC. If additional local installation codes apply, contact local inspection authorities.

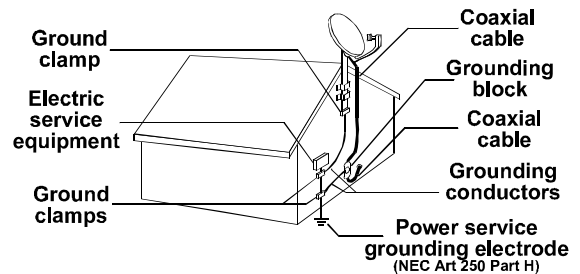

EXAMPLE OF ANTENNA GROUNDING ACCORDING TO THE NATIONAL ELECTRICAL CODE INSTRUCTIONS CONTAINED IN "RADIO AND TELEVISION EQUIPMENT"

Water and Moisture—Do not use this DIRECTV System product near water or moisture.

Television Antenna Information—Installing an outdoor antenna can be hazardous and should be left to a professional antenna installer. Do not locate the outside antenna system in the vicinity of overhead power lines or other electric light or power circuits, or where it can fall into such power lines or circuits. When installing an outside antenna system, take extreme care to keep from touching such power lines or circuits as contact with them might be fatal. If an outside antenna is connected to the digital satellite receiver, be sure the antenna system is grounded so as to provide some protection against voltage surges and built-up static charges. Section 810 of the NEC, NFPA No. 70 1987, provides information with respect to proper grounding of the mast and supporting structure, grounding of the lead-in wire to an antenna discharge unit, size of the grounding conductors, location of antenna discharge unit, connection to grounding electrodes, and requirements for the grounding electrode.

Power Lines—Extreme care must be taken when installing and adjusting or maintaining the outdoor antenna and connecting cable, especially in the vicinity of overhead power lines, electric lights, or power circuits. When installing the outdoor antenna or cable, extreme care should be taken to keep from touching or approaching such power lines or circuits, as contact with them might be fatal.

Cleaning—Unplug this DIRECTV System product from the wall outlet before cleaning. Do not use liquid cleaners or aerosol cleaners. Use a damp cloth for cleaning.

Object and Liquid Entry—Never push objects of any kind into this DIRECTV System product through openings as they may touch dangerous voltages or “short out” parts that could result in a fire or electric shock. Never spill liquid of any kind on the DIRECTV System product.

SERVICE

Servicing—Do not attempt to service this DIRECTV System product yourself as opening or removing covers may expose you to dangerous voltage or other hazards. There are no user serviceable parts inside. Refer all servicing to qualified service personnel.

Conditions Requiring Service—Unplug this DIRECTV System from the wall outlet and refer servicing to qualified personnel under the following conditions:

- When the power supply cord or plug is damaged.
- If liquid has been spilled on, or objects have fallen into, the DIRECTV System product or it has been exposed to water.
- If the DIRECTV System product does not operate normally by following the operating instructions. Adjust only those controls that are covered by the operating instructions. Improper adjustment of other controls may result in damage and will often require extensive work by a qualified technician to restore the DIRECTV System product to its normal operation.
- If the DIRECTV System product has been dropped or the cabinet has been damaged.
- When the DIRECTV System product exhibits a distinct change in performance.

Replacement Parts—When replacement parts are required, have the technician verify that the replacements being used have the same safety characteristics as the original parts. Use of replacement parts specified by the DIRECTV System product manufacturer can prevent fire, electric shock, or other hazards.

Safety Check—Upon completion of any service or repairs to this DIRECTV System product, ask the service technician to perform safety checks recommended by the manufacturer to determine that the DIRECTV System product is in safe operating condition.

THESE ARE DEFINITIONS FOR ALERTS USED IN THIS MANUAL



WARNING or CAUTION

Where you see this alert symbol and the WARNING or CAUTION heading, strictly follow the warning instructions to avoid personal injury.



DANGER

Electric shock hazard: Where you see these symbol and the DANGER heading, strictly follow the warning instructions to avoid electric shock injury



CAUTION

RISK OF ELECTRIC SHOCK
DO NOT OPEN



CAUTION: TO REDUCE THE RISK OF ELECTRIC SHOCK,
DO NOT REMOVE COVER (OR BACK).
NO USER-SERVICEABLE PARTS INSIDE.
REFER SERVICING TO QUALIFIED SERVICE PERSONNEL.

THESE ALERTS APPEAR IN THIS MANUAL

WARNING



For your own safety, follow these important safety rules:

- Perform as many functions as possible on the ground.
- Do not install the satellite dish antenna on a rainy or windy day.
- If you start to drop the satellite dish antenna or mast assembly, get away from it and let it fall.

DANGER



Do not select a location to install the satellite dish antenna near power lines. You can be *killed* if the satellite dish antenna comes into contact with electric power lines.

- Do not contact overhead power lines
- Check the distance to any nearby power lines before starting installation. Stay at least 20 feet away from all power lines.
- If any part of the satellite dish antenna or mast assembly comes into contact with a power line, call your local power company. *Do not try to remove it yourself.* They will remove it safely.

CAUTION



Local electric codes and the National Electric Code (NEC) require the satellite dish antenna to be grounded. Grounding the satellite dish antenna helps protect against damage caused by static voltage buildup. Grounding can also protect against voltage surges created by

FEDERAL COMMUNICATIONS COMMISSION (FCC) REGULATORY INFORMATION

Federal Communications Commission (FCC)—The HNS brand DIRECTV System complies with both Part 15 and Part 68 of the FCC rules.

Part 15 compliance—

This equipment has been tested and found to comply with the limits for a Class B digital device, pursuant to Part 15 of the FCC rules. These limits are designed to provide reasonable protection against harmful interference in a residential installation. This equipment generates, uses and can radiate radio frequency energy and, if not installed and used in accordance with the instructions, may cause harmful interference to radio communications.

However, there is no guarantee that interference will not occur in a particular installation. If this equipment does cause harmful interference to radio or television reception, which can be determined by removing and applying power to the equipment, the user is encouraged to try to correct the interference by one or more of the following measures:

- Reorient or relocate the receiving satellite dish antenna.
- Increase the separation between the equipment and the digital satellite receiver.
- Connect the equipment into an outlet on a circuit different from that to which the digital satellite receiver is connected.
- Consult the dealer or an experienced radio/TV technician for help.

The user may find the following booklet, prepared by the Federal Communications Commission, helpful: "How to Identify and Resolve Radio and TV Interference Problems." This booklet is available from the U.S. Government Printing Office, Washington, DC.

To meet FCC requirements, only peripherals (computer input/output devices, terminals, printers, etc.) certified to comply with the Class B limits may be attached to this device. Operation with non-certified peripherals is likely to result in interference to radio and TV reception.

To meet FCC requirements, shielded cables are required to connect the device to a personal computer, peripheral, or other Class B certified device.

Part 68 compliance—

1. The FCC has established Part 68 of the FCC Rules, which permit this device to be directly connected to the telephone network. Standardized jacks are used for these connections. This equipment should not be used on coin lines or party lines.
2. If this device is malfunctioning, it may also be causing harm to the telephone network; this device should be

disconnected until the source of the problem can be determined and until repair has been made. If this is not done, the telephone company may temporarily disconnect service.

3. The telephone company may make changes in its technical operations and procedures; if such changes affect the compatibility or use of this device, the telephone company is required to give adequate notice of the changes. You will be advised of your right to file a complaint with the FCC.
4. If the telephone company requests information on what equipment is connected to their lines, inform them of:
 - the telephone number this unit is connected to.
 - the ringer equivalence number (REN). The number can be found on a label located on the bottom of the equipment.
 - the Universal Service Order Code (USOC) jack required. This equipment requires a USOC RJ11 jack.
 - the FCC registration number. The number can be found on a label located on the bottom of this equipment.

TABLE OF CONTENTS

A FIRST LOOK AT THE DIRECTV DIGITAL SATELLITE RECEIVER 1-1

- What You Should Do First* 1-1
- How Does All This Work?* 1-1
- DIRECTV SYSTEM COMPONENTS 1-2
 - The Satellite Dish Antenna* 1-2
 - The Digital Satellite Receiver* 1-2
 - The Remote Control* 1-3

SETTING UP YOUR DIRECTV SYSTEM 2-1

- INSTALLING REMOTE CONTROL BATTERIES 2-1
- CHOOSING THE BEST CONNECTION FOR YOUR ENTERTAINMENT SYSTEM 2-2
 - Hook Up the Audio/S-video Signals* 2-2
 - Hook Up the Audio/Video Signals* 2-3
 - Hook Up the RF Signals* 2-3
 - Hook Up to a Stereo System* 2-4
 - Finishing Up* 2-4
- CONNECTING THE VCR CONTROL CABLE 2-4
 - Finding the VCR's Remote Control Sensor* 2-5
- NOW YOU CAN TURN IT ON 2-5

CONTROLLING THE DIGITAL SATELLITE RECEIVER 3-1

- FRONT PANEL VS. REMOTE CONTROL KEYS 3-1
- BASIC NAVIGATION 3-1

INSTALLING THE SATELLITE DISH ANTENNA 4-1

- DETERMINE WHERE TO POINT YOUR SATELLITE DISH ANTENNA 4-2
 - The INSTALLATION screen* 4-2
 - ALIGNMENT RESULT Pop-up Panel* 4-2
- CHOOSING THE ANTENNA INSTALLATION SITE ... 4-2
- SELECTING A MOUNTING OPTION 4-5
- INSTALLING THE SATELLITE DISH ANTENNA ONTO A WOODEN SURFACE 4-6
- INSTALLING THE SATELLITE DISH ANTENNA ONTO A BRICK SURFACE 4-8
- INSTALLING THE SATELLITE DISH ANTENNA ONTO A CINDER BLOCK SURFACE 4-9
- INSTALLING THE SATELLITE DISH ANTENNA ONTO A METAL POLE 4-11
- ATTACHING THE REFLECTOR ONTO THE LNB SUPPORT ARM 4-11
 - Assembling the Satellite Dish Antenna* 4-11
- ATTACHING THE SATELLITE DISH ANTENNA ASSEMBLY TO THE MAST OR POLE 4-12
- GROUNDING THE METAL POLE MOUNT 4-13
- GROUNDING THE BASE PLATE 4-13
- INSTALLING AND ROUTING THE LNB COAXIAL CABLE 4-14
- CONNECTING THE COAXIAL CABLE TO THE LNB 4-15

- ATTACHING THE LNB TO THE LNB SUPPORT ARM 4-16
- ROUTING THE LNB CABLE TO THE SATELLITE RECEIVER 4-16
- CONNECTING THE SATELLITE DISH ANTENNA .. 4-16
- POSITIONING THE SATELLITE DISH ANTENNA ... 4-16
 - The INSTALLATION Screen* 4-17
 - Pointing the Satellite Dish Antenna Using the "Box" Method* 4-18
- AUTHORIZING YOUR SERVICE 4-20

WATCHING DIRECTV SYSTEM PROGRAMMING 5-1

- BASIC CHANNEL CHANGING 5-1
 - The Channel Banner* 5-1
 - The Information Banner* 5-1
 - The OneLine™ Guide* 5-2
 - TurboTune™* 5-2
 - AlphaTune™* 5-2
- ALTERNATE SERVICES 5-3
 - Alt. Audio* 5-3

THE ON-SCREEN GUIDES 6-1

- Choosing the Guide Style* 6-1
- Descriptions* 6-1
- General On-Screen Guide Features* 6-2
- Using PreSelect to Schedule Programs for Taping* 6-2
- Using PreSelect™ to Schedule Programs for Viewing* 6-2
- THE PROGRAM GUIDE (SM. CELL) 6-3
- THE PROGRAM GUIDE (LG. CELL) 6-4
- THE TITLE GUIDE 6-5
- THE LOGO GUIDE 6-5
- THE WATCHWORD™ GUIDE 6-6
- FILTERING THE GUIDES 6-6
 - Theme Filters* 6-6
 - Channel List* 6-7
 - Guide Times* 6-7
 - Class Filters* 6-8
- THE INFORMATION SCREEN 6-8
 - Done* 6-8
 - View* 6-8
 - PreSelect* 6-8
 - PreSelect To View* 6-9
 - Cancel PreSelect* 6-9
 - Buy \$* 6-9
 - Buy Options* 6-9
 - Cancel Purchase* 6-10
 - Show Times* 6-10

DIGITAL SATELLITE RECEIVER'S MENU SYSTEM 7-1

- Menu Overview* 7-1
- MAIN MENU 7-2

Setup.....	7-2
Scheduler	7-2
Check Mail.....	7-2
Purchases.....	7-2
Help.....	7-2
Lock/Unlock.....	7-2
SETUP MENU	7-3
Preferences	7-3
Limits.....	7-3
Chan. Lists	7-3
TurboTune™.....	7-3
Installation.....	7-3
VCR Setup.....	7-3
WatchWord	7-4
Current settings overview	7-4
SCHEDULER.....	7-4
Editing an event.....	7-4
CHECK MAIL	7-5
Message	7-5
Page	7-5
Erase	7-6
PURCHASES	7-6
History/Upcoming	7-6
Purchase History.....	7-6
Upcoming Purchases.....	7-6
LOCK/UNLOCK.....	7-7
Locking Procedure	7-7
Unlocking Procedure	7-7
Temporarily Overriding the Lock	7-8
PREFERENCES.....	7-8
Advanced.....	7-8
MultiColor	7-9
Chan. Tags.....	7-9
Chan. Sort.....	7-9
Scheme	7-9
Language	7-9
Filters.....	7-9
ADVANCED PREFERENCES.....	7-9
Receiver ID	7-10
Phone Prefix.....	7-10
Screen Ratio.....	7-10
Channel Lock.....	7-10
Input Key.....	7-10
Demo Mode.....	7-10
Factory Defaults.....	7-10
LIMITS	7-11
TV Allow	7-11
Max Rating.....	7-11
Max Spending	7-12
CHANNEL LISTS	7-12
Rename.....	7-12
Auto Set.....	7-12
Clear	7-13
Set.....	7-13
Tag Boxes.....	7-13
TURBOTUNE™.....	7-13
Set Channel.....	7-14
INSTALLATION.....	7-14

System Test.....	7-14
Transponder #.....	7-14
Position	7-14
New Card.....	7-15
SYSTEM TEST	7-15
Receiver Test.....	7-15
Cable Test	7-15
VCR SETUP.....	7-16
Brand.....	7-16
Code	7-16
Test (Record/Stop).....	7-16
WATCHWORD	7-17
WatchWord #	7-17

PROGRAMMING YOUR REMOTE CONTROL

..... 8-1

PROGRAMMING THE REMOTE CONTROL	8-1
Programming Mode	8-1
Code Scan	8-1
Code Entry.....	8-1
USING THE REMOTE CONTROL.....	8-3
Switching the Remote Control to Operate	
Additional Digital Satellite Receiver	8-4
Identifying Codes that Have Been Stored.....	8-4
Controlling Other Components Using the AUX	
Button.....	8-4

A FIRST LOOK AT THE DIRECTV DIGITAL SATELLITE RECEIVER



Congratulations! You've selected one of the most advanced digital video and audio components available today. You now have the capability to receive hundreds of channels of video programming and CD-quality audio.

What You Should Do First

Your DIRECTV System is both a sophisticated technical product and an easy-to-operate source of entertainment. You should complete the following steps to achieve the greatest performance from your system:

- Read this manual to familiarize yourself with the system.
- Install the digital satellite receiver.
- Install your satellite dish antenna and cable.
- Align the satellite dish antenna.
- Arrange for programming from the service providers.
- Enjoy endless hours of TV entertainment.

How Does All This Work?

{ XE "Service providers" } Many film studios, news organizations and other broadcasters provide their

video, audio, and data services to DIRECTV and USSB uplink centers. These service providers then digitally transmit the signals 22,300 miles in space to a grouping of three high-powered satellites built by Hughes Electronics. These satellites are co-located in geosynchronous orbit. This means that after installation of the DIRECTV System, which includes aiming the satellite dish antenna at the satellites, no adjustment will be necessary to change channels because everything comes from the same locations in the sky. The satellite dish antenna never has to track the satellite, so there's no waiting for the picture to come in. From there the digital signals are beamed back to earth where they are received by your satellite dish antenna. The signals then go into the digital satellite receiver where they undergo extensive processing to determine if you are authorized to access them. The signals are then reconverted into high-quality video and audio that you can enjoy on your television. The telephone connection is used by the digital satellite receiver to report back to the service providers any purchase activity.

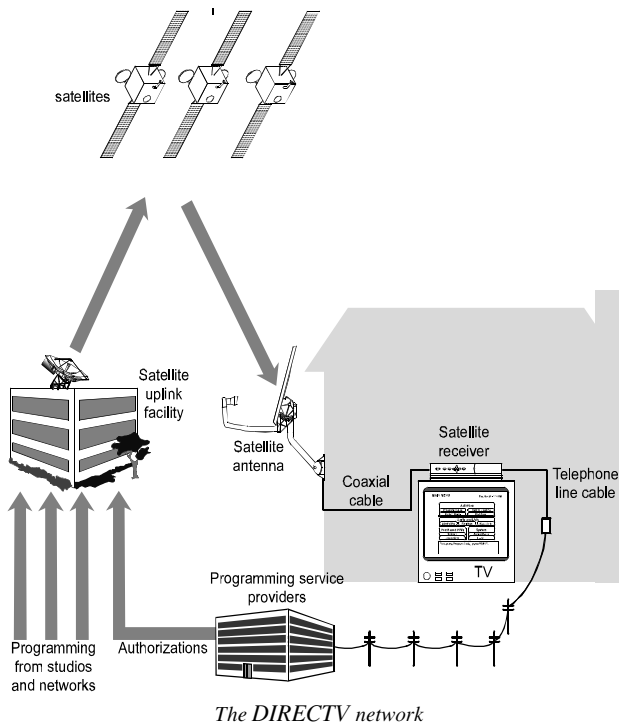

DIRECTV System Components

There are three main components of your DIRECTV System. They are the satellite dish antenna, the digital satellite receiver, and the remote control. Take a few minutes to read about each one.

The Satellite Dish Antenna

{ XE "Satellite antenna:components" }The satellite dish antenna is the component that receives the digital signals. It must be mounted to a solid outdoor surface that allows a clear view of the southern sky.

The large circular part is known as the reflector. At the end of a tubular arm that is attached to the satellite dish antenna, there is a low noise block (LNB). The mounting bracket and base make adjustments easy during installation. Once the satellite dish antenna has been properly positioned to point towards the satellites, you should never need to adjust it again.

Satellite dish antennas will have either a single LNB or a dual LNB. The single LNB has one connection, allowing use of a single digital satellite receiver. The dual LNB has two connections, allowing use of two digital satellite receivers, or more if you are using a multi-switch.

The mounting bracket and base make adjustments easy during installation. Once the satellite dish antenna has been properly positioned to point toward the satellites, you should never need to adjust it again.

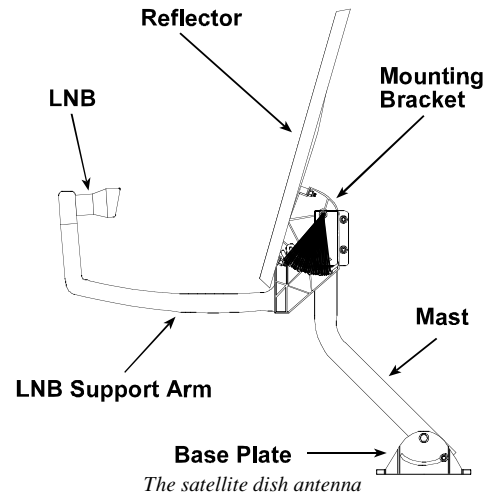

The Digital Satellite Receiver

{ XE "Receiver:front panel" }This digital satellite receiver is one of the most compact available today. Nearly every feature of the digital satellite receiver can be accessed from the front panel keys.

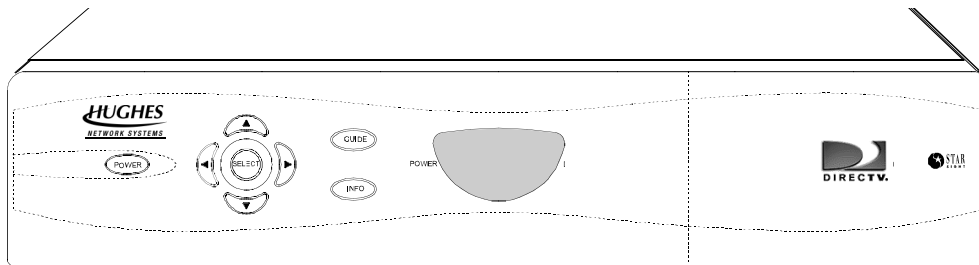

Your access card is located behind the door on the right side of the digital satellite receiver{ XE "Access card" }{ XE "Receiver:door" }. This special card contains information about your level of service and holds pay per view purchase activity. This card should not be removed except to protect the digital satellite receiver from unauthorized use or to replace the card when your service provider (DIRECTV or USSB) supplies a new one.

The power key (**POWER**) is used to turn the digital satellite receiver on and off. The power light (located in the center) will illuminate when the unit is on. Any off-air signal, such as cable TV or local programming, connected to the **IN FROM ANT** jack is passed through to the **OUT TO TV** jack when the digital satellite receiver power is off.

The information key (**INFO**) is used to display descriptions of DIRECTV System programs and channels on your TV screen.

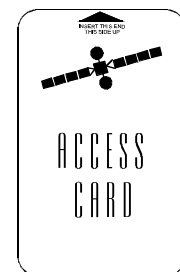

The DIRECTV System Access Card

At any time, pressing the program guide key (**GUIDE**) will initiate the display of the on-screen guide, where you can see a listing of all available programs, or will display the **GUIDE MENU** if pressed while displaying a program guide.

The four directional keys, up (**▲**), down (**▼**), left (**◀**), and right (**▶**), are used to move the highlight around the program guide and menus. They also provide access to the **OneLine™ Guide** when menus aren't displayed.

The select key (**SELECT**) is used to access a highlighted guide or menu item.

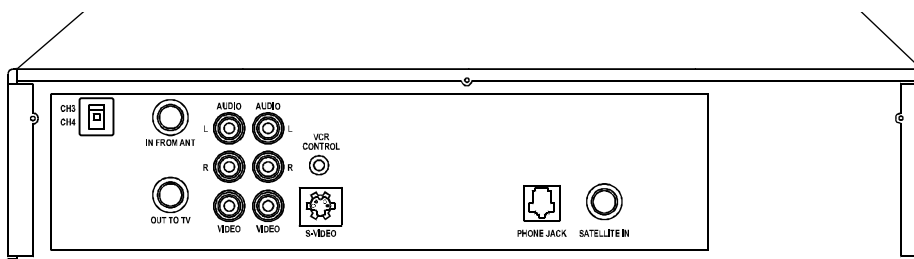

The rear of the digital satellite receiver.

{ XE "Receiver:rear jacks" } { XE "Hookup:rear jacks" } The rear of the digital satellite receiver has numerous jacks for connection to your audio/video entertainment system. You will also find the power cord permanently connected to the back.

The **SATELLITE IN** F-type jack is for connecting the cable from your satellite dish antenna to the digital satellite receiver. Be sure that you use RG-6 cable only.

The **IN FROM ANT** F-type jack is an input where you can connect the cable from an RF terrestrial source such as an off-air antenna or cable TV service.

The **OUT TO TV** F-type jack is an RF output which you may connect to your TV or VCR (depending on your entertainment system). Note that the CH3/CH4 switch on the upper left enables you to select the channel for your TV on which the DIRECTV System programming appears.

The phono-type AUDIO output jacks, labeled and color coded (**L** is white, **R** is red) to indicate left and right, can be used for connection to your TV, VCR, or audio system. The phono-type composite VIDEO output jack is color-coded yellow. You may use this jack for connection to your TV or VCR. The multiple-pin **S-VIDEO** jack is for high-quality output of DIRECTV System video. Use this jack to achieve the clearest picture for your TV or VCR. Only newer high-end TVs, SVHS VCRs and Hi8 VCRs support S-video connections.

The standard RJ-11 modular **PHONE JACK** is for connecting the digital satellite receiver to your phone line. This phone connection is necessary to access certain program offerings from your service providers. Any calls generated by the digital satellite receiver are toll free. The telephone line connection will not normally interfere with your telephone operation. The digital satellite receiver will, however, call a toll-free number briefly to report any pay per view programs that may have been purchased.

The **VCR CONTROL** mini-jack is for connecting the VCR control cable included with the system. With this cable, the digital satellite receiver can interface with most popular brands of VCRs to record selected programs automatically.

The Remote Control

The HRMC-5 remote control can control your DIRECTV System and most TV brands, as well as VCRs and many other auxiliary devices such as cable boxes, amplifiers, and laser disc players.

The remote control uses an invisible infrared light to send signals to your components when you press the keys. You must aim the remote control toward the component for it to receive the command.

The mode keys across the top of the remote control enable you to specify the device you intend to control. This is important since many devices share the same keys, such as the **POWER** key and the numeric keys. **You must press the appropriate device key before pressing a command key to make sure the remote control sends the right signal to the right device.** The only keys that deviate from the rule are the blue keys, as they are always associated with the digital satellite receiver.

The arch of keys immediately below the power and mode keys control frequently used functions. These include special action (**ACTION**), information (**INFO**), guide (**GUIDE**), exit (**EXIT**), and favorite (**FAV**) keys.

The **ACTION** key is unique because it does nothing by itself. Pressing it displays the action icon in the upper left corner of your screen for a few seconds. During that time, other keys may be pressed to access special functions indicated in yellow above the keys. Each will be described later in this manual. The following chart describes the **ACTION** key functions for easy reference:

Key Combination	Feature	Function
ACTION GUIDE	MENU	Displays the MAIN MENU from any screen
ACTION FAV	LIST	Displays the CHANNEL LISTS screen from any screen
ACTION PREV CH	SERVICES	Displays the Alternate Services menu while in video
ACTION 1	MOVIES	Filters the on-screen guide to movies only
ACTION 2	SPORTS	Filters the on-screen guide to sports only
ACTION 3	NEWS	Filters the on-screen guide to news only
ACTION 0	ALL	Resets the on-screen guide filters

Four directional keys will cause the on-screen highlight to move in the direction you want. The key positions will be referred to as **◀**, **▶**, **▲**, and **▼**.

The select key (**SELECT**) is one of the most important keys. Pressing the **SELECT** key will tell the digital satellite receiver that you wish to choose the highlighted item.

The remaining keys are either digital satellite receiver-specific keys and common device keys including numbers, channel up and down, etc. The functions of these keys change depending on the device currently selected.

Please refer to “Controlling the Digital Satellite Receiver” for more remote control capabilities and “Programming Your Remote Control” for teaching your remote control about your other audio/video components.

Descriptions and details of each individual key will be given in the appropriate sections throughout this manual.



The HRMC-5 remote control

SETTING UP YOUR DIRECTV SYSTEM

2

Setting up your new DIRECTV System is much easier than assembling a train set or a bicycle. You should be watching satellite programming in a very short time!

This chapter provides step-by-step instructions for setting up your DIRECTV System and connecting it to your television or entertainment system. As you are reading this now, it is assumed that you have already opened and unpacked the box.

The carton includes the digital satellite receiver itself, an access card (already installed in the digital satellite receiver behind the door), a remote control (batteries included), cables, and this manual. Contact your dealer if anything is missing or damaged. Please save all packing materials until the installation of your system is complete in case anything needs to be returned.

You now need to decide where you want to place the digital satellite receiver. Choose a location near your TV where the power cord or cables will not be inadvertently disconnected. The location should also be well ventilated. Do not set electronic components or other objects (including this manual) on top of the digital satellite receiver or otherwise block its cooling vents.

It is recommended that you have your DIRECTV System professionally installed. This is due to safety issues, electrical codes, and assurance of a quality installation. **If you should choose to perform the installation yourself, please pay special attention to the precautions in the front of this manual and refer to the chapter "Installing and Pointing Your Satellite Dish Antenna."** You may also want to obtain the *Do-It-Yourself Installation Kit*, sold separately.

Installing Remote Control Batteries

{ XE "Remote control:batteries" } Before the remote control can be used, the supplied batteries need to be installed. First, unsnap the battery cover from the back of the remote control. Install each fresh battery as shown, making sure that the + and - on each battery line up with the marks in the battery compartment. Next, snap the cover back onto the remote control.

Refer to "Programming Your Remote Control" for setting the codes to control the devices in your entertainment system.

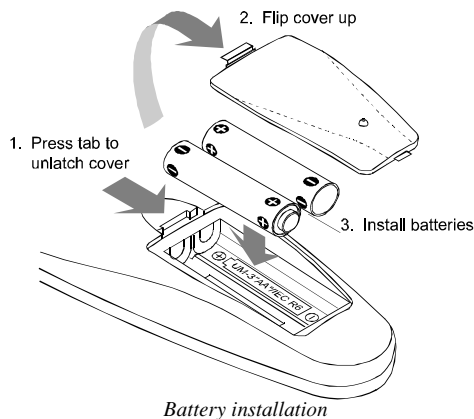

Choosing the Best Connection for Your Entertainment System

{ XE "Hookup:overview" } There are a number of ways to connect the digital satellite receiver, depending on the other audio/video equipment you wish to use. The simplest hookups are shown here.

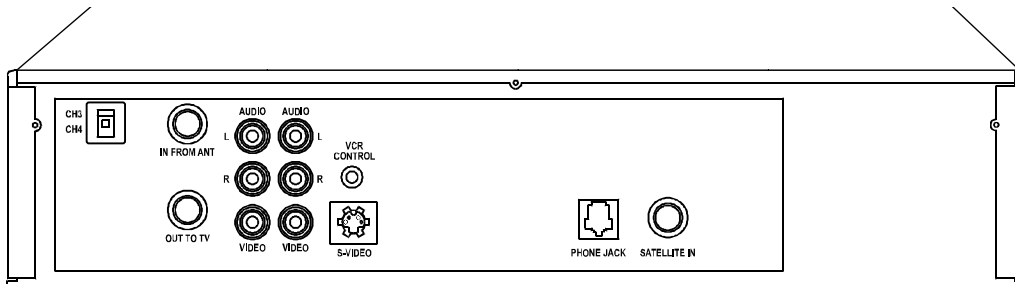

Possible connections

{ XE "Hookup:phone jack" } Before connecting the digital satellite receiver to your entertainment system, you should connect the phone line. This can be done by plugging one end of the provided telephone cable into the **PHONE LINE** jack on the back of the digital satellite receiver and the other end into a telephone wall jack. If you do not have a telephone jack within reach, you may have a new one installed or reorient the digital satellite receiver to be within reach of a telephone wall jack.

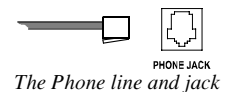

The Phone line and jack

You may need to purchase additional connectors and/or cables to suit specific needs from your dealer or electronic hardware stores. Choose which hookup method to use based on:

- The capabilities of your TV and VCR.
- Your desire to pass local programming through the digital satellite receiver.
- Any other devices you want to include in the system (stereo, second VCR, etc.).

Before attempting to connect anything, position yourself so you are looking at the back of your components. Note the various input and output receptacles, their shapes, and how they are labeled. Then read through the rest of this hookup section before going ahead with actual hookup.

Do not turn on the power yet. For your safety, make sure the digital satellite receiver, TV, VCR, and any other devices to be connected are unplugged from the wall outlet while hooking them up.

Hook Up the Audio/S-video Signals

{ XE "Hookup:S-video" } Only the newest, high-end TVs and VCRs have S-video inputs. VCRs that support S-video include Hi8 and SVHS types. Look on the back of your TV and VCR for this special jack. It will probably be labeled **S-VIDEO IN**. If you are unsure, you can see the type of connector that you are looking for on the back of the digital satellite receiver. If neither the TV nor VCR has this jack, proceed to the "Hook Up the Audio/Video Signals" section.

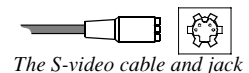

The S-video cable and jack

This hookup will give you the sharpest picture of any of the hookups. Also, this hookup will allow you to view DIRECTV System programming and local broadcast simultaneously on TVs with "picture in picture" (PIP) feature.

When using this hookup, you cannot use the digital satellite receiver as a switch to choose between DIRECTV System programming and local broadcasts. Instead, you will use the input selection that your TV and/or VCR offers to select the source.

If your VCR has S-video input...

use an S-video cable to connect the digital satellite receiver's **S-VIDEO** output to the S-video input on your VCR. Also connect one pair of the digital satellite receiver's audio outputs (Left and Right) to the audio inputs on your VCR.

If your TV has S-video input...

connect an S-video cable from the **S-VIDEO** output (either from the digital satellite receiver if available or the VCR) to the S-video input on the TV. Also connect the left and right audio outputs from the same device that the S-video is coming from and connect them to the TV.

If you have a stereo system...

you may be able to achieve big speaker sound. See the "Hook Up to a Stereo System" section for the necessary connections.

If your hookup is complete...

move on to the "Finishing Up" section.

Hook Up the Audio/Video Signals

{ XE "Hookup:video" } Most high-end TVs and VCRs have phono-type audio and video inputs. Look at the back of your TV and VCR for three jacks—possibly color coded yellow, white and red. They will be labeled something like **IN (L and R)**, **AUDIO IN**, and **VIDEO IN**. If you are unsure, look at these connectors on the back of the digital satellite receiver. If you have no jacks like these on your TV or VCR, skip this section and proceed to the "Hook Up the RF Signals" section.

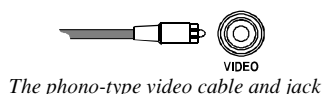

The phono-type video cable and jack

This video hookup will give you a clearer picture than an RF hookup. Also, this hookup will allow you to view DIRECTV System programming and local broadcast simultaneously on TVs that offer a "picture in picture" (PIP) feature.

When using this hookup, you cannot use the digital satellite receiver as a switch to choose between DIRECTV System programming and local broadcasts. Instead, you will use the input selection that your TV and/or VCR offer to select the source.

If your VCR has a video input...

use an audio/video cable to connect the digital satellite receiver's **VIDEO** output to the video input on your VCR. Also connect the pair of the digital satellite receiver's audio outputs (Left and Right) to the audio inputs on your VCR.

If your TV has a video input...

connect an audio/video cable from the **VIDEO** output (from either the digital satellite receiver, if available, or the VCR) to the video input on the TV. Also, connect the left and right audio outputs from the same device that the video is coming from and connect them to the TV.

If you have a stereo system...

you may be able to achieve big speaker sound. See the "Hook Up to a Stereo System" section for the necessary connections.

If your hookup is complete...

move on to the "Finishing Up" section.

Hook Up the RF Signals

{ XE "Hookup:RF" } Look at the back of your TV and VCR for RF inputs. These may be labeled **75-OHM**, **300-OHM**, **CABLE**, **FROM ANTENNA**, **VHF** or **UHF**. These could appear either as a pair of screws or an F-type connector as on the back of the digital satellite receiver.

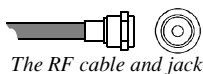

The RF cable and jack

If your TV or VCR does not have threaded F-type connectors you will need to obtain adapters which convert the round F-type RG-6 or RG-59 cable to the connectors on your TV and/or VCR. These are sold separately and should be available from your dealer or an electronics hardware store.

To connect your VCR...

use a coaxial cable to connect the **OUT TO TV** from the digital satellite receiver to the RF input section on your VCR. This is the first place where an adapter may be needed if your VCR doesn't have the F-type connector.

To connect your TV...

connect a coaxial cable from the RF output (from either the digital satellite receiver's **OUT TO TV**, if available, or the VCR) to the RF input on the TV.

Set the channel 3/4 selector switch on the back of the digital satellite receiver to the channel that is not broadcast or has the weakest signal in your area. This will be the channel that you need to set your TV and/or VCR to for viewing or recording DIRECTV System programming.

You can also use the digital satellite receiver as a switch to select between DIRECTV System programming and local broadcasts. This can be accomplished by pressing the **INPUT** key while the remote is in DIRECTV System mode. Also, you must connect your local signal, either from an antenna or cable service, to the **IN FROM ANT** on the back of the digital satellite receiver. If your antenna wire is not a coaxial type you will need an adapter as described earlier.

If you have a stereo system...

you may be able to achieve big speaker sound. See the "Hook Up to a Stereo System" section for the necessary connections.

If your hookup is complete...

move on to the "Finishing Up" section.

Hook Up to a Stereo System

{ XE "Hookup:stereo system" }To achieve high-quality sound from the digital satellite receiver through a stereo system, simply connect the **AUDIO** outputs (Left and Right) to an available input on your audio system. First, look for an input labeled **AUX**. If you aren't using a compact disc player or laser disc player, you can use one of those inputs, if available. The only input that you should not use is one that is specified for a turntable/phonograph.

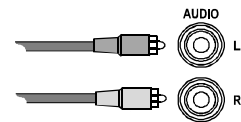

The phono-type audio cable and jack

Finishing Up

You can mix and match the different hookups described above to suit your entertainment system's available connections. For example, you could connect the VCR using audio/video, while the TV is connected with the RF signal. Always try to achieve the highest quality and greatest flexibility available.

Once all connections have been completed, plug in the TV, VCR and digital satellite receiver to the wall outlet, appropriate extension cord, or surge protector. See *Important Safety Instructions* described in the front of this manual.

Note: If you have connected a VCR into your entertainment system in a way that routes the cables from the digital satellite receiver to your VCR before the signal reaches the TV, you may experience a distorted picture if you attempt to record a copy-protected program. These programs are identified by a "Can't Tape" symbol in the banner area of the screen. If this occurs, simply stop the recording process and your picture will automatically correct itself.

Connecting the VCR Control Cable

{ XE "Hookup:VCR Control" } { XE "VCR:control cable" }With the proper connections you can have the digital satellite receiver control your VCR for unattended recording. First, plug the VCR Control cable into the back of the digital satellite receiver. Then proceed to the next section to determine where the other end of the cable should be attached.

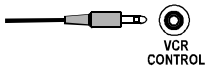

The VCR Control cable and jack

Finding the VCR's Remote Control Sensor

So that the digital satellite receiver can control your VCR the emitter end of the VCR control cable must be attached where the VCR's remote control sensor is located. On some VCRs this is labeled. You may also find a diagram in your VCR manual indicating the sensor position. It is commonly identifiable by a small dark plastic window. For reference, see the sensor on the digital satellite receiver located in the center.

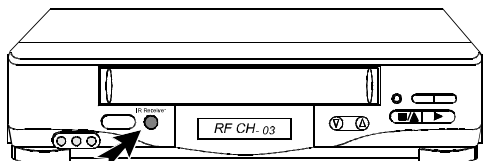

Look for indications of the remote control sensor

If the sensor is not labeled or documented, you will need to scan the front of your VCR with your VCR remote control. Use the following procedure to accomplish this:

- Hold the VCR remote control about 1/2-inch from the front left side of your VCR.
- Slowly move the remote control to the right repeatedly pressing the remote control's power key on and off.
- Once your VCR responds to your pressing the remote control power, note the position. This should be the location of your VCR IR sensor.

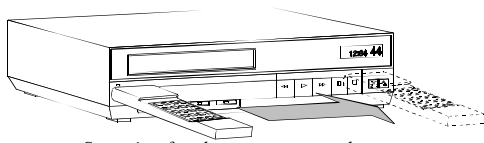

Scanning for the remote control sensor

Once the sensor position has been determined, temporarily attach the emitter to the area with a piece of tape until the system can be tested. Refer to the "VCR Setup" section in the chapter "The Digital Satellite Receiver's Menu System" to program and test the VCR Control feature.

Upon verifying that the VCR control is functioning properly you can remove the tape and permanently attach the emitter using the peel-and-stick backing. This attachment should not interfere with normal VCR operation.

Now You Can Turn It On

Once you have connected everything, you can begin powering up the components. Turn the TV on and set it to the DIRECTV System channel (3 or 4) or input (video or S-video). Do the same for the VCR, if applicable. Now turn the digital satellite receiver on. You will see the start-up screen for several seconds, followed by a black screen with the message at the bottom:

"Searching for satellite signal. To access related utilities, press **SELECT**."

If so, this is good! If not, try pressing the **INPUT** key while the remote control is in DIRECTV System mode. If that doesn't work, check all of the connections.

You're well on your way to enjoying your DIRECTV System.

CONTROLLING THE DIGITAL SATELLITE RECEIVER

3

Now it's time for you to take control. Take a few minutes to read through this chapter to begin to understand how to operate your system. Let's begin with a few simple rules. First, there is nothing that you can do, using the front panel keys or the remote control keys, which could harm the digital satellite receiver in any way. Once you understand the capabilities and options available in your receiver, you'll be able to undo any changes or settings that you make.

The next important rule is to have fun. The features of the digital satellite receiver are intended to make watching TV more enjoyable. It isn't necessary to know everything your system can do right away. Learn the capabilities a little at a time. As you use the digital satellite receiver, the techniques necessary to control it will become second nature.

Front Panel vs. Remote Control Keys

{ XE "Receiver:front panel" } { XE "Remote control" } The front panel provides all the basic controls needed to access and use the primary features of the digital satellite receiver. The remote control has additional keys to provide shortcuts or access to extended features of the digital satellite receiver. Most of the remote control keys can also be used to control other components in your entertainment system. For this reason, you must remember to press the **SAT** key, putting the remote control in digital satellite receiver mode, when you want to control the digital satellite receiver.

Basic Navigation

The most common digital satellite receiver-related keys that you will use are **▲**, **▼**, **◀**, **▶**, and **SELECT**. Four distinct keys on the digital satellite receiver front panel represent the direction keys. On the remote control, the direction keys are represented by the top, bottom, left and right keys surrounding the **SELECT** key. These keys are primarily used to move the highlight (also known as a cursor) around the screen. The **SELECT** key should be pressed to indicate that a highlighted item is the one that you wish to choose.

Another key you will be using frequently is the **GUIDE** key, located on both the front panel of the digital satellite receiver and on the remote control. This key is used when you want to display the current on-screen guide. Once you are in the guide, pressing the **GUIDE** key while a program title is highlighted will display the Guide pop-up menu.

Another key appearing on both the front panel and the remote control is the **INFO** key. This key is used to retrieve descriptive information about a currently airing event and to provide access to scheduling information (and purchasing information for pay per view) about highlighted programs in the on-screen guide.

The final key that appears on both the remote control and the front panel is the **POWER** key. Make sure the remote control is in DIRECTV System mode for the **POWER** key to apply to the digital satellite receiver. When you power the digital satellite receiver off, it has not actually stopped using electricity. Rather, it goes into a standby mode which enables it to continue monitoring data sent from the service providers, call in status reports to the service providers, start and stop your VCR for programs you

have scheduled, receive messages, and perform other background activities. The only apparent changes occurring in the standby mode are that the video goes black, the **IN FROM ANTENNA** connector signals are passed through to the **OUT TO TV** connector, and the power light is off.

There are three keys on your remote control that most people use frequently. They are the **FAV**, **EXIT**, and **INPUT** keys.

After you have established favorite channel lists, as described in the chapter “The Digital Satellite Receiver’s Menu System,” you will want to cycle through them quickly and easily. Do so by pressing the **FAV** key. Each press will advance to the next list of channels. After stepping through the favorite lists it will cycle back to “All Channels.”

At any time, you can exit the on-screen guide by selecting *Video* in the Guide pop-up menu. An even faster way is to press the **EXIT** key.

The **INPUT** key is only useful if the digital satellite receiver is connected to your entertainment system through the **OUT TO TV** connector, rather than **VIDEO** or **S-VIDEO**. If you are using **OUT TO TV**, pressing the **INPUT** key will switch the output between DIRECTV System programming and local broadcasts similar to the way the **POWER** key works.

Knowing these few keys should enable to navigate through almost every digital satellite receiver feature and menu.

INSTALLING THE SATELLITE DISH ANTENNA

4

There's a cluster of satellites way out there in space, and just as a telescope is pointed at a star, you need to point your satellite dish antenna at the satellites. In this chapter we will explain the basic process for determining where to mount and how to point your satellite dish antenna.

Read the contents of this chapter, as well as the important safety information in the front of this manual. These instructions are intended for an installer experienced in performing the various tasks described here. Depending on how you intend to install the antenna, you may be required to:

- Climb a ladder and work on your roof.
- Use a power drill to drill holes in your house.
- Determine if there are water pipes, electrical wiring, or gas lines hidden in the walls near where you will be drilling.
- Route coaxial cable through the foundation wall, under floors, and through interior walls.
- Ground the antenna and coaxial cable as recommended in the National Electrical Code (published by the National Fire Protection Association, Batterymarch Park, Quincy, MA 02269).

If you are unsure about your ability to perform these tasks or comply with installation requirements, contact your DIRECTV System dealer for information regarding professional installation.

Successfully installing and obtaining the satellite signals can be a time consuming and tedious task. For that reason, it is highly recommended that you contact a professional installer to get you up and running. The warranty covering your DIRECTV System assumes professional installation and may not apply in self installation situations since improper installation could damage the various components or cause undesired performance.

Your satellite dish antenna will need to be pointed at a satellite cluster located 22,300 miles in orbit above the equator. To aim the satellite dish antenna at the satellites you need to know the azimuth and elevation angles. The digital satellite receiver will assist you in determining these angles. If you see the message:

“Searching for satellite signal. To access related utilities, press **SELECT**.”

press the **SELECT** key. Otherwise, press keys in the following order to navigate to the **INSTALLATION** screen:

- **ACTION** **GUIDE** to display the **MAIN MENU**
- **▲** or **▼** to move the highlight over the *Setup Menu* button
- **SELECT** to display the **SETUP MENU**
- **▲** or **▼** to move the highlight over the *Installation* button
- **SELECT** to display the **INSTALLATION** screen

Determine Where to Point Your Satellite Dish Antenna

The INSTALLATION screen

{ XE "Satellite antenna:pointing" } { XE "DISH POINTING MENU" } When you press **SELECT** you will see a screen that assists you with the satellite dish antenna pointing and signal strength utilities.

Move the highlight to the *Position* button and press **SELECT**. You will need to determine your location by either ZIP code or by your latitudinal and longitudinal position. Press the **▲** or **▼** keys on the remote control or receiver front panel until your preferred selection is highlighted. Then press **SELECT**.

You will now see a pop-up panel with space to enter your information. Enter your location. If you are using the remote control, press the **SAT** key, followed by the five appropriate digits. From the remote control or receiver front panel you can also use the **▲** or **▼** keys to increase or decrease the highlighted digit value, and the **▶** key to advance to the next digit. Use the **◀** key to back up to correct any mistakes. When you are finished, highlight the *OK* button and press **SELECT** to continue.

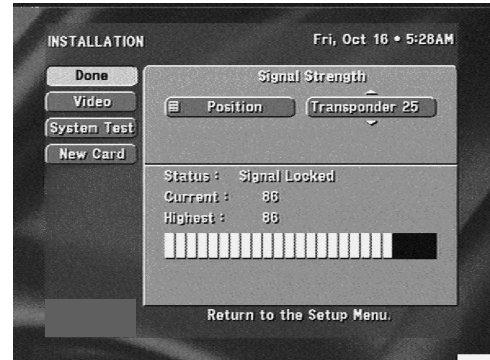

The INSTALLATION screen

{ XE "ZIP CODE screen" } { XE "LATITUDE & LONGITUDE screen" } ALIGNMENT RESULT Pop-up Panel

{ XE "ALIGNMENT RESULT screen" } The **ALIGNMENT RESULT** will display the proper elevation and azimuth for pointing the satellite dish antenna calculated from the information you entered. Take a moment to write down the pointing results.

ELEVATION: _____

AZIMUTH: _____

The values displayed are fairly accurate; however some fine-tuning may be necessary. Use these values when choosing a mounting location for your satellite dish antenna and remember that you will need an unobstructed view in that direction.

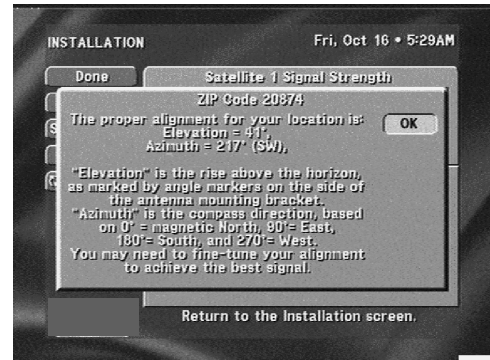

The ALIGNMENT RESULT screen

Choosing the Antenna Installation Site

WARNING



For your own safety, follow these important safety rules:

- Perform as many functions as possible on the ground.
- Do not install the antenna on a rainy or windy day.

INSTALLING AND POINTING YOUR SATELLITE DISH ANTENNA

- If you start to drop the antenna or mast assembly, get away from it and let it fall.
-

Perform the following steps to select the best site to install the antenna:

- 1) Go to the location where you plan to install the antenna.
- 2) Using a compass like the one shown, hold the compass level so that the needle can rotate freely. When the needle stops rotating, it will be pointing north. Doing so carefully so as not to disturb the needle, rotate the body of the compass so that the 0° or N marks printed on the compass align with the painted end of the needle. The compass is now aligned with magnetic north.

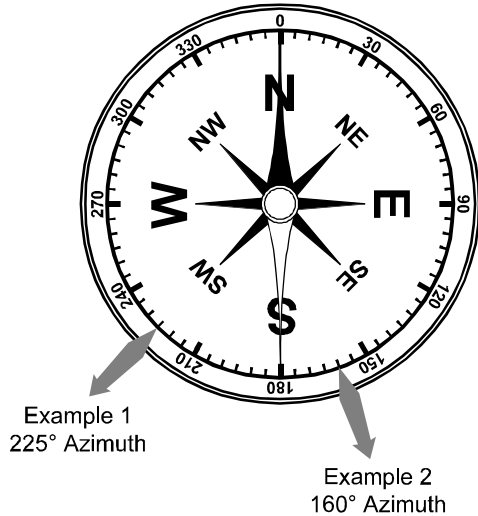

Note: Large metal structures, such as air conditioning units and steel beams near the compass may greatly reduce its accuracy. If you are near such structures, move several feet away and repeat the measurement to verify the readings.

- 3) Draw an imaginary line from the center of the compass to the azimuth value you recorded above. This is the direction for pointing the satellite dish antenna toward the satellites. Use a rock or some other object to mark the location where you are standing; then pick a landmark in the distance that aligns with the magnetic azimuth bearing, or mark the azimuth in some way.

- 4) Verify that there are no obstructions (such as buildings or trees) blocking the view to the satellite, as shown in the diagram.

Remember that trees that are small now or do not have leaves could grow to ultimately block the clear line of sight.

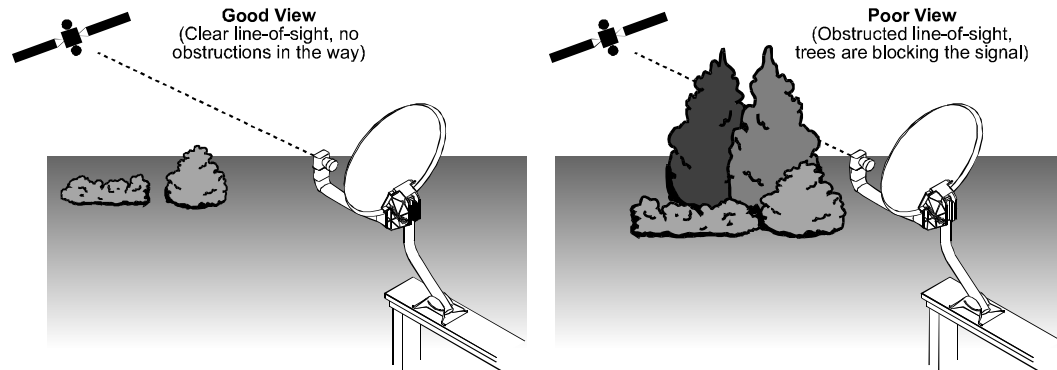

- 5) Make sure that the site you have chosen is not where people or equipment could hit the satellite dish antenna.

DANGER



Do not select a location to install the satellite dish antenna near power lines. You can be *killed* if the satellite dish antenna comes into contact with electric power lines.

- Do not contact overhead power lines
 - Check the distance to any nearby power lines before starting installation. Stay at least 20 feet away from all power lines.
 - If any part of the satellite dish antenna or mast assembly comes into contact with a power line, call your local power company. *Do not try to remove it yourself.* They will
-

remove it safely.

If you decide to install the satellite dish antenna yourself, we recommend you purchase the *Do-It-Yourself Installation Kit*. It contains many items you will need to complete most installations.

You will need some of the following tools, depending on your installation:

- Electric drill
- Drill bits (1/8-inch, 3/16-inch, 1/2-inch masonry)
- Carpenter's level
- Pencil or chalk
- Tape measure
- Wrenches (3/8-inch, 7/16-inch, or adjustable)
- Hammer
- Hole digging tools
- Wheelbarrow or concrete mixing box
- Hacksaw
- Sledge hammer
- Flat blade screwdriver
- Phillips screwdriver

Confirm that you have all of the satellite dish antenna kit components.

- Steel reflector (1)
- Mast (1)
- Base plate (1)
- LNB support arm (1)
- LNB (1)
- $\frac{1}{2}$ -inch nuts (5)
- Retainer screw (2)
- Cable clip (1)
- Flat head screws (4)
- $\frac{1}{4}$ -20 x $\frac{1}{2}$ -inch grounding bolt (1)

If you are missing any parts contact the Customer Care Center at 1-800-274-8995.

Selecting a Mounting Option

Now that you have chosen where you want to install your satellite dish antenna, you need to select the appropriate mounting. Use the options described below to determine the section of this chapter that you should advance to.

All installations require grounding per NEC 810-15 and NEC 820-33.

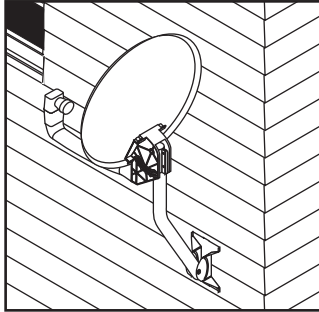

Installing the satellite dish antenna on the side of your house. Do not install on vinyl or aluminum siding. See the section titled “Installing the Satellite Dish Antenna Onto a Wooden Surface.”

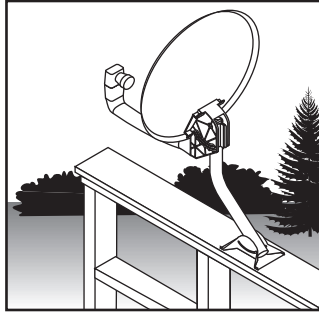

Installing the satellite dish antenna on the rail or floor of a deck. See the section titled “Installing the Satellite Dish Antenna Onto a Wooden Surface.”

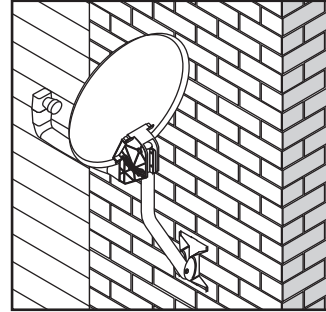

Installing the satellite dish antenna on a brick surface. See the section titled “Installing the Satellite Dish Antenna Onto a Brick Surface.”

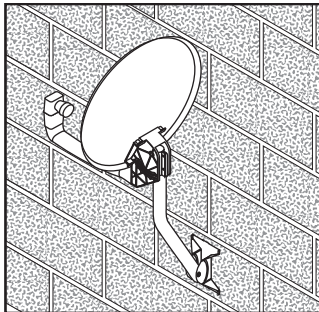

Installing the satellite dish antenna on a cinder block or masonry surface. See the section titled “Installing the Satellite Dish Antenna Onto a Cinder Block Surface.”

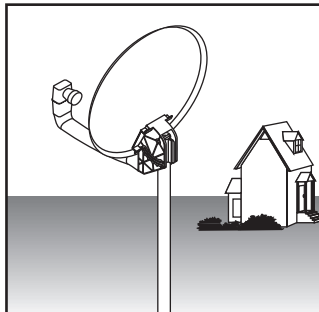

Installing the satellite dish antenna on a metal pole. See the section titled “Installing the Satellite Dish Antenna Onto a Metal Pole.”

Note: If you will be installing the satellite dish antenna base plate and mast using a mounting configuration other than the ones recommended here, do so as follows:

1. Install the base plate and mast.
2. Verify that the mast is level.
3. Go to the section titled “Attaching the Reflector Onto the LNB Support Arm.”

Installing the Satellite Dish Antenna onto a Wooden Surface

The satellite dish antenna can be installed onto several types of wooden surfaces. This section describes installing the satellite dish antenna base plate and mast onto the side of your house or on a deck rail or floor.

Do not mount the satellite dish antenna onto composite (also called particleboard or fiberboard) surfaces unless there is a wall stud or rafter located where you will be installing the mounting hardware. Composite materials are not strong enough to support the satellite dish antenna during strong winds and other violent weather conditions.

Have the following tools and materials handy during this process. Items marked with an asterisk (*) indicate that they are included in the *Do-It-Yourself Installation Kit* (sold separately).

- Drill bits (1/8-inch, 3/16-inch)
- Carpenter's level
- Pencil or chalk
- Electric drill
- Silicone sealant *
- Washers * (5/16-inch, Qty. 4)
- Wrenches (3/8-inch, 7/16-inch)
- Lag screws * (3-inch x 1/4-inch, Qty.2; 2-inch x 5/16-inch, Qty.4)

Installation Procedure

- 1) Select a secure site to install the satellite dish antenna base plate:

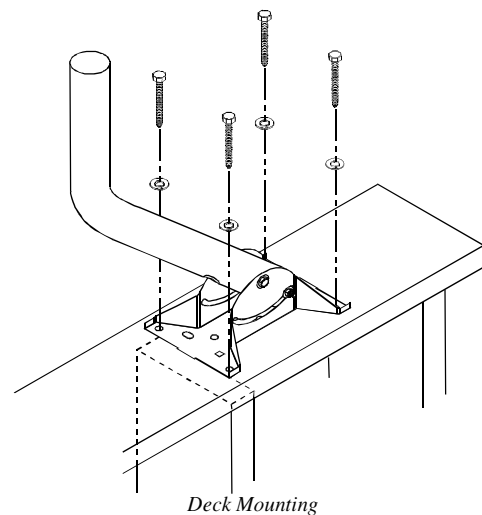
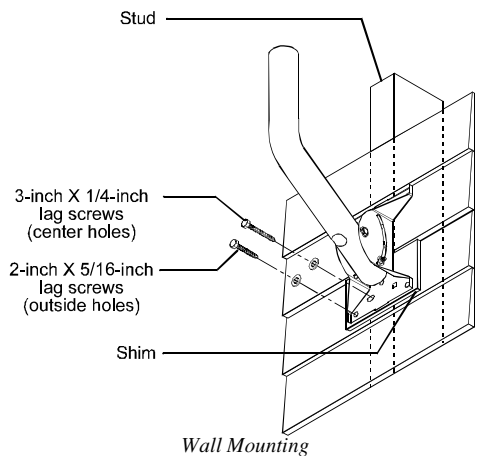

- On the side of your house. Locate a wall stud onto which you can install the antenna base plate as shown. Wall studs can most easily be found by looking for the line of nails that shows where siding is attached to the house or by using a stud finder.
 - On a deck railing or floor. You can install the base plate onto a deck rail or on the deck floor as shown.
- 2) Place the base plate so the center holes align with the centerline of the rafter or stud (see diagram). While holding the base plate in place, use a pencil to mark the location of the top center hole onto the mounting surface. This mark indicates where you will be drilling later.
 - 3) Using a carpenter's level, plumb the antenna mast in at least two different locations on the side of the mast, as shown. These two measurements should be at right angles to each other. If the mast is plumbed (aligned vertically with the bubble level), go to step 5. Otherwise, loosen the pivot bolt and adjustment nuts (see diagram).

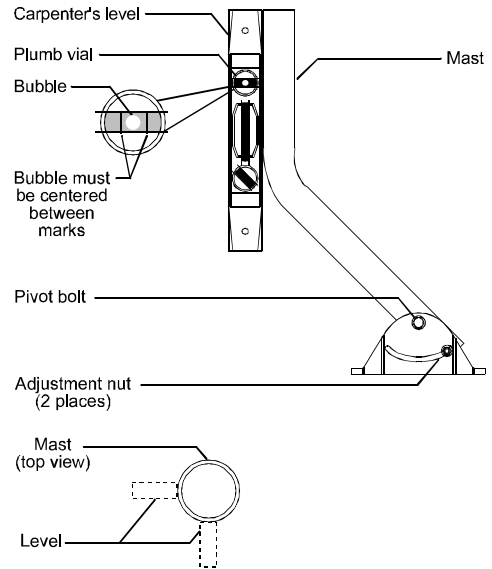
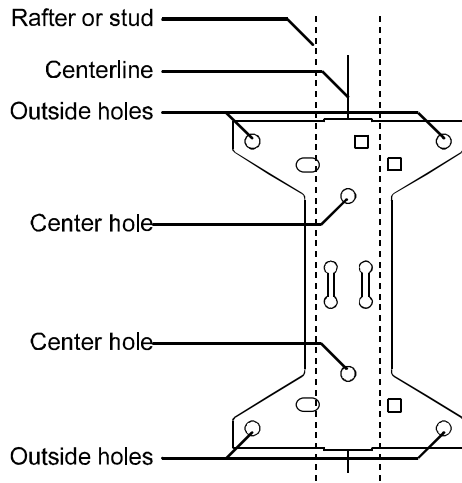

- 4) Rotate the mast until it is plumb with the level, then tighten the pivot bolt and alignment nuts. If you are still unable to align the mast with the level, try using wooden shims. If they do not correct the problem you will need to find another site to install the satellite dish antenna.
- 5) Set the mast aside and drill a 1/8-inch x 3-inch pilot hole where you made the pencil mark.
- 6) Install the mast assembly onto the mounting surface using a 3-inch x $\frac{1}{2}$ -inch lag screw. Tighten the screw enough to secure the base plate, but leave it loose enough to enable you to adjust the base plate.
- 7) Verify that the mast is still plumb and adjust if necessary.
- 8) Mark the locations of the outside holes and remaining center hole on the mounting surface.
- 9) Remove the base plate from the mounting surface.
- 10) Drill a 1/8-inch x 3-inch pilot hole for the lower center hole.
- 11) Drill four 1/8-inch x 2-inch pilot holes for the outside holes.
- 12) While holding the base plate in place, apply silicone sealant onto the six pilot holes and around the bottom edge of the base where it contacts the mounting surface (see diagram). Doing so will help prevent water from seeping into your house.

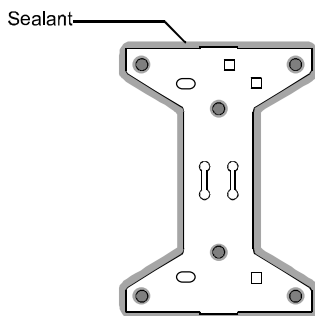

- 13) Install four 2-inch x 5/16-inch lag screws and four 5/16-inch washers into the outside holes on the base plate.
- 14) Install two 3-inch x $\frac{1}{2}$ -inch lag screws into the center holes on the base plate.
- 15) Tighten all screws.
- 16) Apply additional silicone sealant to cover the tops of the lag screws.

With the base plate and mast installed, proceed to the section titled "Attaching the Reflector Onto the LNB Support Arm" later in this chapter.

Installing the Satellite Dish Antenna onto a Brick Surface

The satellite dish antenna can be installed onto brick surfaces. This section describes installing the satellite dish antenna base plate and mast onto the side of your brick house or on a chimney.

Have the following tools and materials handy during this process. Items marked with an asterisk (*) indicate that they are included in the *Do-It-Yourself Installation Kit* (sold separately).

- Masonry drill bit (3/8-inch)
- Machine screws * (1/2-inch x 3-inch, Qty. 4)
- Carpenter's level
- Pencil or chalk
- Silicone sealant *
- Expansion anchors* (Qty. 4)
- Washers * (5/16-inch, Qty. 4)
- Wrenches (3/8-inch, 7/16-inch, or adjustable)
- Hammer

Installation Procedure

- 1) Select a flat and secure site to install the satellite dish antenna base plate.
- 2) Place the base plate so the outside holes are positioned over the brick surfaces. Do not drill into the mortar between the bricks.

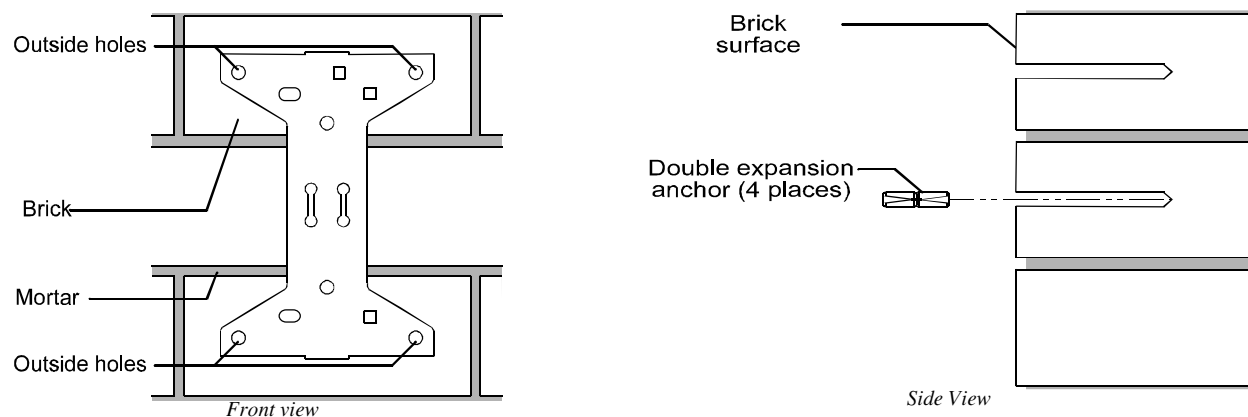

- 3) Using a carpenter's level, plumb the satellite dish antenna mast in at least two different locations on the side of the mast, as shown. These two measurements should be at right angles to each other. If the mast is plumb (aligned vertically with the bubble level), go to step 5. Otherwise, loosen the pivot bolt and adjustment nuts (see diagram).
- 4) Rotate the mast until it is plumb with the level, then tighten the pivot bolt and alignment nuts. If you are still unable to align the mast with the level, try using wooden shims. If they do not correct the problem you will need to find another site to install the satellite dish antenna.
- 5) Use a pencil to mark the location of the top left outside hole of the base plate (see diagram) onto the brick surface.
- 6) Set the mast aside and drill a 3/8-inch x 3-inch hole where you made the pencil mark.
- 7) Clean out the hole and insert an expansion anchor. The anchor should fit snugly, so you may have to use a hammer to gently tap the anchor until it is flush with the brick surface.

- 8) Install the mast assembly onto the mounting surface using a 3-inch x $\frac{1}{4}$ -20 machine screw (see diagram). Tighten the screw enough to secure the base plate, but leave it loose enough to enable you to adjust the base plate.

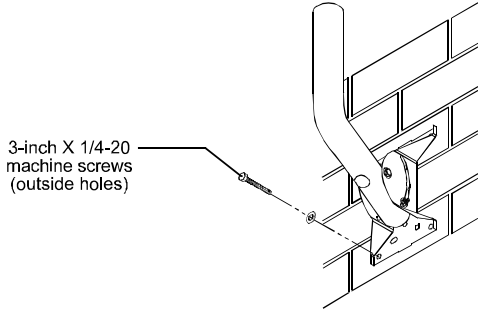

- 9) Verify that the mast is still plumb and adjust if necessary.

- 10) Mark the locations of the other three outside holes on the mounting surface.

- 11) Remove the base plate from the brick surface.

- 12) Drill three $\frac{1}{2}$ -inch x 3-inch holes for the outside holes.

- 13) Install the base plate using the 3-inch x $\frac{1}{4}$ -20 machine screws and four $\frac{5}{16}$ -inch washers.

- 14) Tighten the four machine screws.

With the base plate and mast installed, proceed to the section titled “Attaching the Reflector Onto the LNB Support Arm” later in this chapter.

Installing the Satellite Dish Antenna onto a Cinder Block Surface

The satellite dish antenna can be installed onto brick surfaces. This section describes installing the satellite dish antenna base plate and mast onto a cinder block or masonry surface.

Have the following tools and materials handy during this process. Items marked with an asterisk (*) indicate that they are included in the *Do-It-Yourself Installation Kit* (sold separately).

- Masonry drill bit ($\frac{1}{2}$ -inch)
- Machine screws * ($\frac{1}{2}$ -inch x 3-inch, Qty. 4)
- Carpenter’s level
- Pencil or chalk
- Electric drill
- Silicone sealant *
- Toggles* (Qty. 4)
- Washers * ($\frac{5}{16}$ -inch, Qty. 4)
- Wrenches ($\frac{3}{8}$ -inch, $\frac{7}{16}$ -inch, or adjustable)
- Hammer

Installation Procedure

- 1) Select a flat and secure site to install the satellite dish antenna base plate.
- 2) Tap the cinder blocks with a hammer to locate the hollow center cores.
- 3) Place the base plate so the outside holes are positioned over the hollow center cores of the cinder block. Do not drill into the mortar between the cinder blocks.

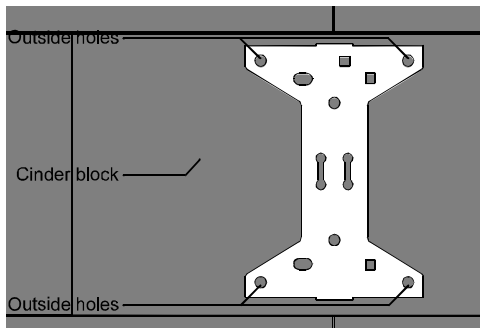

- 4) Using a carpenter's level, plumb the satellite dish antenna mast in at least two different locations on the side of the mast, as shown. These two measurements should be at right angles to each other. If the mast is plumb (aligned vertically with the bubble level), go to step 5. Otherwise, loosen the pivot bolt and adjustment nuts (see diagram).
- 5) Rotate the mast until it is plumb with the level, then tighten the pivot bolt and alignment nuts. If you are still unable to align the mast with the level, try using wooden shims. If they do not correct the problem you will need to find another install site.
- 6) Use a pencil to mark the location of the top left outside hole of the base plate (see diagram) onto the cinder block surface.
- 7) Set the mast assembly aside and drill a $\frac{1}{4}$ -inch hole where you made the pencil mark.
- 8) Clean out the hole.
- 9) Install the toggler as follows: Holding the ring end of a toggler, fold the metal channel flat against the toggler and insert it into the drilled hole until you feel the channel open inside the hollow core of the cinder block. Rotate the toggler and gently pull the ring to ensure the metal channel is flat against the inside of the cinder block. While pulling the toggler toward you to apply tension, slide the push-cap until it is snug against the cinder block. Break the ring along the center perforation and bend the two straps away from each other until they break at the push-cap. Break the ring along the center perforation and bend the two straps away from each other until they break at the push-cap.

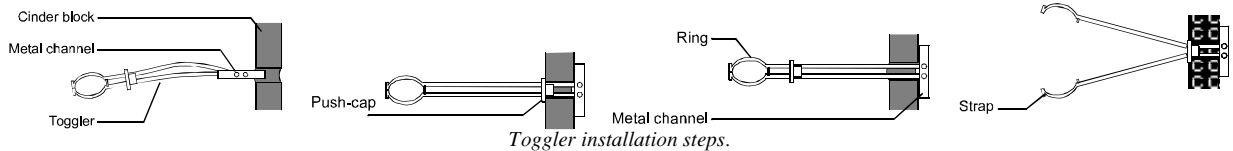
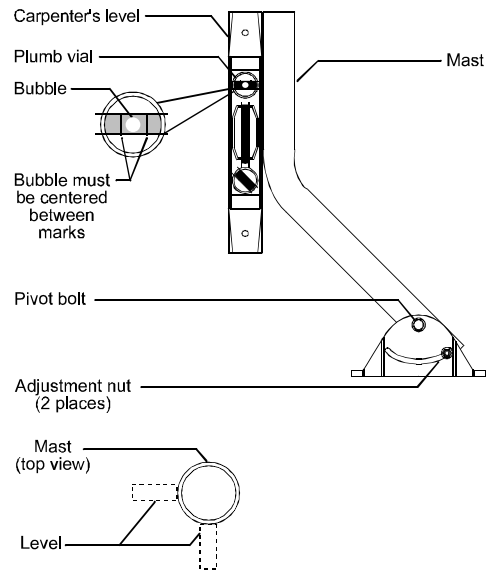

- 10) Install the mast assembly onto the cinder block surface using a 3-inch x $\frac{1}{4}$ -20 machine screw (see diagram). Tighten the screw enough to secure the base plate, but leave it loose enough to enable you to adjust the base plate.
- 11) Verify that the mast is still plumb and adjust if necessary.
- 12) Mark the locations of the other three outside holes on the cinder block surface.
- 13) Remove the base plate from the cinder block.
- 14) Drill three $\frac{1}{4}$ -inch holes for the outside holes.
- 15) Repeat steps 8 through 12 to install togglers in the three drilled holes.
- 16) Install the base mast assembly using the 3-inch x $\frac{1}{4}$ -20 machine screws and four $\frac{5}{16}$ -inch washers.
- 17) Tighten the four machine screws.

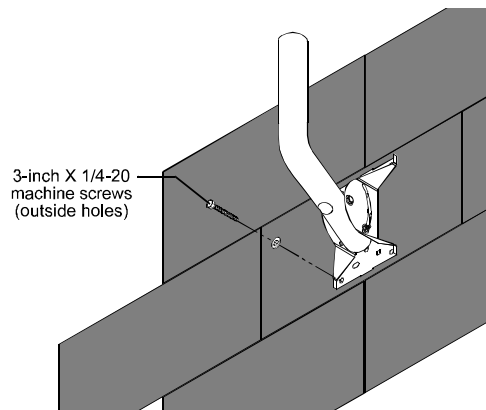

With the base plate and mast installed, proceed to the section titled "Attaching the Reflector onto the LNB Support Arm" later in this chapter.

Installing the Satellite Dish Antenna onto a Metal Pole

The satellite dish antenna can be installed onto a metal pole. You will not be using the base plate or mast included with the satellite dish antenna for this procedure. Store these items in case you decide to move the satellite dish antenna to a new location in the future.

Have the following tools and materials handy during this process. Items marked with an asterisk (*) indicate that they are included in the *Do-It-Yourself Installation Kit* (sold separately).

- Hole digging tools
- Wheelbarrow or concrete mixing box
- Carpenter's level
- Pencil or chalk
- Guy wires and wooden stakes
- Hacksaw
- 40-pound bag of quick setting concrete (Qty 4)
- Metal pole (1_-inch inside diameter schedule 40 galvanized water pipe - 6-foot length minimum)

Installation Procedure

- 1) Use a hacksaw to cut the bottom edge of the pole at a 45° angle, as shown. This prevents the pole from rotating in the concrete over time.

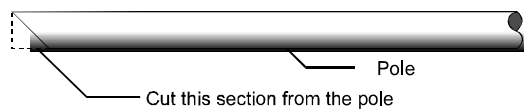

- 2) Dig a hole at least 8-inches in diameter and 36-inches deep. If you live in an area where the frost line goes deeper than 30-inches, dig the hole at least 6-inches deeper than the frost line.

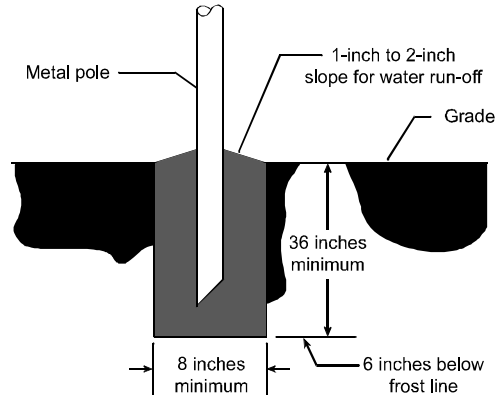

- 3) Place the pole into the hole and place rocks (for example) around the pole to stabilize it in a vertical position.
- 4) Fill the hole with prepared quick drying cement. Shape the top of the concrete with a slope to improve drainage.
- 5) Using a carpenter's level, plumb the pole in at least two different locations on the side of the pole, as shown. These two measurements should be at right angles to each other. When the pole is plumb, secure it with the rocks, or attach guy wires to hold it upright.
- 6) Let the cement dry for 24 hours before you remove the guy wires or attempt to attach the satellite dish antenna to the pole.

With the pole installed, proceed to the section titled "Attaching the Reflector Onto the LNB Support Arm" later in this chapter.

Attaching the Reflector onto the LNB Support Arm

Assembling the Satellite Dish Antenna

- 1) Insert a flat-head screw into one of the holes in the face of the reflector, as shown.

- 2) Install the mounting bracket of the LNB support arm onto the four flat-head screws, as shown.
- 3) Loosely install a $\frac{1}{4}$ -inch nut onto the portion of each flat-head screw that sticks through the back of the reflector and mounting bracket.
- 4) Tighten the four $\frac{1}{4}$ -inch nuts. The heads of the flat-head screws must be flush on the inside surface of the reflector to be securely fastened to the LNB support arm.
- 5) Install the cable clip as shown.

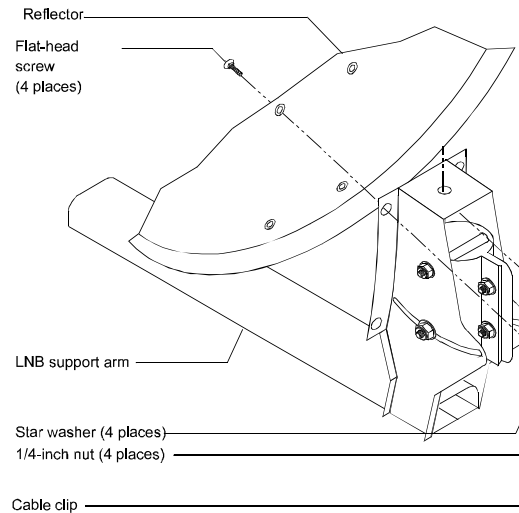

Attaching the Satellite Dish Antenna Assembly to the Mast or Pole

Now that you have assembled the satellite dish antenna you are ready to mount it on your previously installed mast or pole. While the diagrams may show a satellite dish antenna model that differs from the one you have, the same procedures apply.

- 1) If necessary, slightly loosen the azimuth nuts on the LNB support arm.
- 2) Slide the satellite dish antenna assembly onto the mast or pole until the top of the mast stops at the bolt at the top of the mounting assembly.
- 3) Tighten the azimuth nuts enough so that the satellite dish antenna assembly can rotate easily on the mast or pole.
- 4) The next step is to ground the satellite dish antenna.

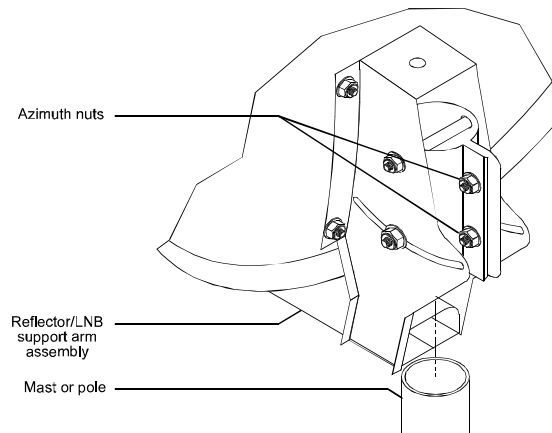

CAUTION



Local electric codes and the National Electric Code (NEC) require the satellite dish antenna to be grounded. Grounding the satellite dish antenna helps protect against damage caused by static voltage buildup or nearby lightning strikes.

Refer to the following:

- Go to the section titled “Grounding the Metal Pole Mount” if your satellite dish antenna is installed on a metal pole.
- Go to the section titled “Grounding the Base Plate” if you satellite dish antenna is installed on the supplied satellite dish antenna mast.

Grounding the Metal Pole Mount

Have the following tools and materials handy during this process. Items marked with an asterisk (*) indicate that they are included in the *Do-It-Yourself Installation Kit* (sold separately).

- 1_-inch ground clamp
- #8 aluminum grounding wire *
- Sledge hammer
- 5/8-inch x 8-foot ground rod and ground rod clamp
- Cable ties *
- Adjustable wrench

Installation Procedure

- 1) Approximately 1 foot from the pole’s cement pier foundation, use a sledge hammer to drive the ground rod 8 feet into the ground.

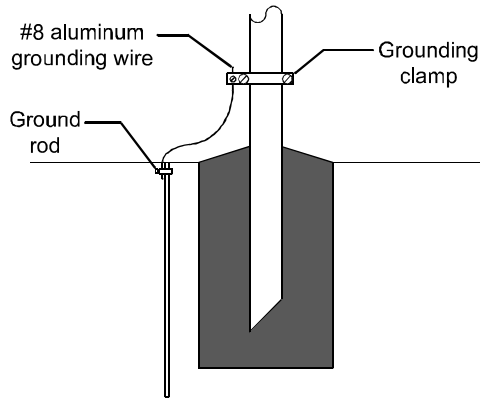

- 2) Install the grounding clamp approximately 1 foot from the base of the pole.

- 3) Install the #8 aluminum grounding wire onto the ground clamp in accordance with National Electric Code 810-15..

- 4) Route the ground wire from the clamp to the ground rod. Use the ground rod clamp to attach the grounding wire to the ground rod.

- 5) Secure the ground wire to the pole using the cable ties.

You can now proceed to the section titled “Installing and Routing the LNB Coaxial Cable.”

Grounding the Base Plate

Have the following tools and materials handy during this process. Items marked with an asterisk (*) indicate that they are included in the *Do-It-Yourself Installation Kit* (sold separately).

- 5/8-inch x 8-foot ground rod
- Adjustable wrench
- Sledge hammer
- ground rod clamp
- #8 aluminum grounding wire *
- Cable ties *

Installation Procedure

- 1) Use a sledgehammer to drive the ground rod 8 feet into the ground near where you installed the satellite dish antenna base plate.

- 2) Insert the $\frac{1}{2}$ x $\frac{1}{4}$ -inch bolt through the grounding hole on the base plate.
- 3) Install the $\frac{1}{2}$ -inch nut onto the bolt.
- 4) Wrap the #8 aluminum grounding wire around the bolt between the star washer and the base plate in accordance with National Electric Code section 810-15, then tighten the nut.
- 5) Route the ground wire from the base plate to the ground rod. Use the ground rod clamp to attach the ground wire to the ground rod.
- 6) If necessary, secure the ground wire to the wall using insulated U-shaped tacks.

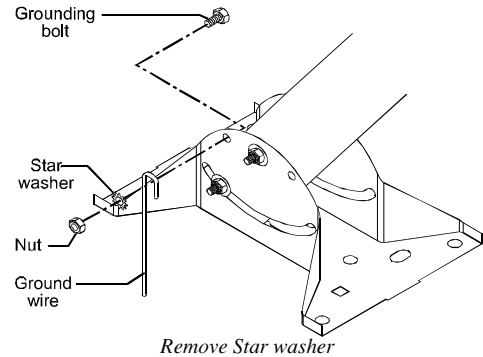

Installing and Routing the LNB Coaxial Cable

This section describes routing and installing the coaxial cable between the LNB and the grounding block. Depending on the routing of the coaxial cable, you may choose to use a cable that can be buried. When normal coaxial cable is buried, its outer cover decays in the soil, and the cable's life is shortened. Cables that are suitable for burial use a special outer cover that resists breakdown. Some of these cables also have a special coating on their ground shields. This coating resists corrosion if water gets into the cable. Anytime the coaxial cable is buried, use cable that is suitable for burial. Doing so will help prevent problems in the future.

An important goal of your cable installation is to protect the cable from physical damage and moisture penetration. To protect the cable from physical damage, secure it to walls or another stable surface with cable clips. This prevents the cable from sagging and being damaged by people stepping on it or running over it with yard equipment. Prevent moisture penetration by using weatherproof connectors, or by sealing any connection that is exposed to the elements. Drip loops provide a connection with additional protection by preventing moisture from traveling down the cable and entering the connection.

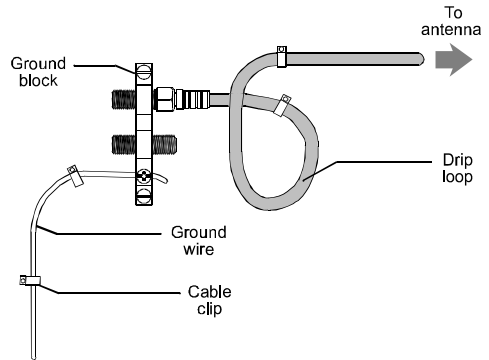

Have the following tools and materials available:

- Phillips screwdriver
- Hammer
- #14 (or larger) insulated grounding wire
- Flat-blade screwdriver

Installation Procedure

- 1) Select the location where you will install the ground block. Choose a site that will be near the cable entry point into the building. Also, plan a short and straight path for the ground wire to the grounding rod.

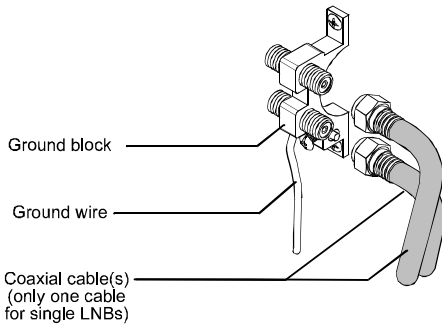

For single LNBs or dual LNB installations using only one side, a single coaxial cable will be used.

- 2) Select a length of cable that can be routed easily from the LNB to the ground block. If your system is equipped with a dual-output LNB, select a second cable that's the same length.

- 3) Secure the grounding block to a stable mounting surface with two screws, then connect the cable(s) to the grounding block.

- 4) Secure the cable(s) with cable clips. Do not forget to form the drip loop and secure it in place with cable clips.

- 5) Install the #14 insulated ground wire on the ground terminal of the ground block in accordance with National Electric Code section 820-33.

- 6) Route the ground wire to the ground rod.

- 7) Connect the ground wire to the ground rod. Remember to secure the wire to a wall or some surface to protect it.

Connecting the Coaxial Cable to the LNB

Installation Procedure

- 1) If you installed the satellite dish antenna assembly onto a metal pole, go to step 2. Otherwise, route the coaxial cable(s) through the mast and LNB support arm. Now continue on to step 3.

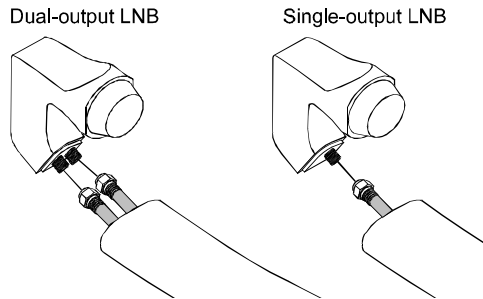

- 2) Route the coaxial cable(s) along the outside of the pole and inside the LNB support arm.

- 3) Insert the cable into the cable clip. This ensures that there will be enough slack in the cable if you need to remove the LNB later. If you are routing two cables, use a cable tie to bind the cables together, then insert one of the cables into the cable clip.

- 4) Attach the coaxial cable(s) onto the LNB as shown.

Attaching the LNB to the LNB Support Arm

- 1) Slide the cable connection end of the LNB into the D-shaped opening in the LNB support arm so that the LNB points toward the reflector. The end of the LNB may be rectangular or D-shaped, however either type will fit.
- 2) Insert the correct size retainer screw into the LNB mounting hole. Two sizes of this screw are provided to accommodate either LNB style.
- 3) Use the appropriate screwdriver to tighten the screw.

Routing the LNB Cable to the Satellite Receiver

During this step of the installation, route the LNB cable from the ground block to the satellite receiver. In most installations, there is more than one way to get the LNB cable to the adapter from the grounding block. If the adapter is near an inside wall, use the crawl space, basement, or attic area. When routing the LNB cable to the digital satellite receiver, take the shortest possible path and always protect it from physical damage.

- 1) *After verifying that there are no wires or pipes blocking the location where you need to feed the coaxial cable into the building*, drill a $\frac{1}{2}$ -inch hole. If you are routing two coaxial cables, drill a second $\frac{1}{2}$ -inch hole near the first.
- 2) Connect one end of the cable to the ground block. Repeat this step if you are routing two cables.
- 3) Form a 3-inch to 5-inch drip loop in the cable(s) before inserting it in the access hole.
- 4) Secure the drip loop(s) and cable(s) to the wall with cable clips.
- 5) Inside the building, route the cable(s) to where the satellite receiver(s) are located. Depending on the installation site, this could be through a floor or wall, directly to the rear of the satellite receiver. If the cable goes straight through a wall, you can use a wall plate at the access point.
- 6) Seal the access point into the building with silicone sealant.

The satellite dish antenna and cable are now completely installed.

Connecting the Satellite Dish Antenna

{ XE "Hookup:satellite" } You must connect the satellite dish antenna cable to receive a signal. *You should unplug your digital satellite receiver from the power outlet prior to making this connection.* Once the satellite dish antenna has been mounted and the satellite cable has been run from the satellite dish antenna to the digital satellite receiver, you are ready to monitor the signal strength while adjusting the satellite dish antenna pointing.

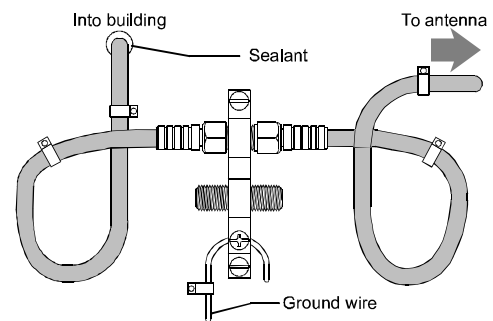
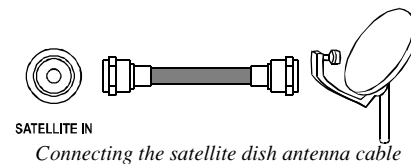

Positioning the

Satellite Dish Antenna

Pointing accuracy is very important. You must be pointing the satellite dish antenna exactly at the satellites for you to receive a signal. Please follow these instructions carefully to achieve a successful installation.

In the following procedure you will be referring to the meter on the **INSTALLATION** screen. If this screen is not currently displayed, press the **POWER** key, shutting the system down, and then press the **POWER** key to start the system up again.

If you see a black screen with the message:

“Searching for satellite signal. To access related utilities, press **SELECT**.”

press the **SELECT** key. Otherwise, press keys in the following order to navigate to the **INSTALLATION** screen:

- **ACTION** **GUIDE** to display the **MAIN MENU**
- **▲** or **▼** to move the highlight over the *Setup Menu* button
- **SELECT** to display the **SETUP MENU**
- **▲** or **▼** to move the highlight over the *Installation* button
- **SELECT** to display the **INSTALLATION** screen

You should see a meter displaying your signal strength.

The **INSTALLATION** Screen

{ XE "SIGNAL STRENGTH screen" }The **INSTALLATION** screen shows the quality of the signal that you are receiving. Because you have not adjusted the direction of your satellite dish antenna, you probably have a signal strength of 0. To let you know that it is “looking,” you should hear a short beep every few seconds.

Even though a signal strength of 50 will give you the same high-quality picture and sound as a reading of 90, you should maximize your signal as much as possible, because rain or snow can cause the signal strength to drop significantly. This signal reduction is known as “rain fade.” As soon as the signal can penetrate the rain cloud or snow, your picture will return automatically.



*The **INSTALLATION** screen*

Pointing the Satellite Dish Antenna Using the “Box” Method

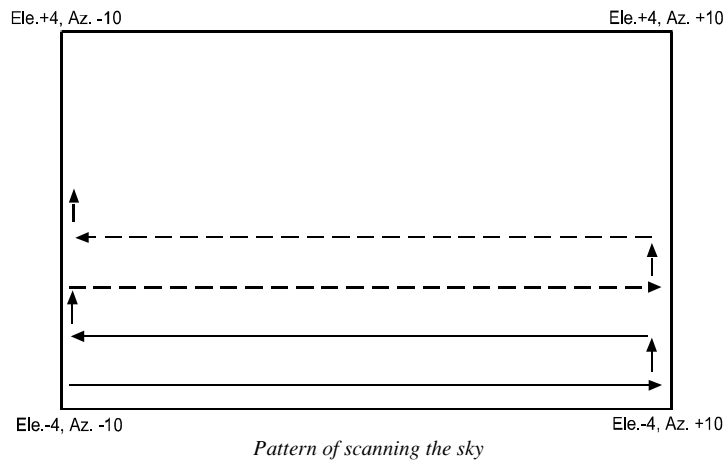

The easiest way to find the satellite signal is by scanning the sky in the general direction that the satellite is located. While you could possibly achieve this by trial and error, you should be able to find the signal in just a few minutes using the “box” method. What you are effectively doing is scanning the sky in a pattern similar to the way a farmer plows a field.

{ XE "Satellite antenna:Fine tuning" }It will be easiest to fine-tune your satellite dish antenna with someone else's assistance, calling out the signal strength while you make the adjustments.

Optionally, you can turn up the volume of your TV so that you can hear the beeps while you make adjustments. When there is no signal, beeps will occur every few seconds so that you know it is searching. As the signal strength increases, the beeps will become much more rapid.

Before you begin make these quick checks:

- Verify that there are no obstructions such as trees, buildings, etc., blocking the signal.
- Verify that you are using the proper cable type (RG-6) between the satellite dish antenna and the digital satellite receiver. Also, be sure that the connections are tight and the center wire in the cable extends about 1/8th-inch beyond the end of the connector.
- Verify that the azimuth and elevation values that you determined earlier are correct for your area.
- { XE "Satellite antenna:Pointing" }To loosen and tighten the satellite dish antenna's bolts, you will need a 7/16-inch wrench (not included).
- A compass will also be needed to establish the initial direction to point your satellite dish antenna.

The “box” method begins by subtracting 10 degrees from the azimuth and subtracting 4 degrees from the elevation values that you determined earlier.

We'll begin by adjusting the elevation. First, loosen the nuts securing the two (one on each side) elevation bolts just enough so that you can easily tilt the reflector up and down. Next, line up the elevation indicator with the tick mark corresponding to the elevation calculated earlier (result minus 4 degrees). **This indicator is the leading edge of the metal just to the left of the bolt. It is recessed inside the slot. Do not use the bolt or nut as a point of reference.** Finish adjusting the elevation by lightly tightening the bolts when the indicator is aligned with the correct tick mark. Make sure that the satellite dish antenna doesn't slip out of position while you are tightening the bolts.

Next, we'll adjust the azimuth. For this part of the procedure, a compass (such as the one included in the *Do-It-Yourself Installation Kit*) will make it possible to point in the proper direction. This is done by first loosening the azimuth bolts just enough in order to turn the satellite dish antenna smoothly with a little pressure. Stand behind or beneath the satellite dish antenna reflector and, while grasping the outer edges of the reflector, rotate the satellite dish antenna until it is pointing toward the azimuth value determined earlier (result minus 10 degrees). Be sure that as you do this you do not lean on the reflector, as that would affect the alignment. Don't tighten the bolts just yet!

- 1) Slowly turn the satellite dish antenna 20 degrees towards and past the actual determined azimuth. It should take about 20 seconds to make the sweep of the sky.
- 2) If no signal was found in this pass, increase the elevation by 1 degree and slowly turn the satellite dish antenna back the other direction. If you do find a signal, go to step 5.
- 3) If you have done this for 9 passes (now 4 degrees above the determined elevation), start back at the beginning point and try again. If you cannot achieve any signal after several tries, call your dealer or the Customer Care Center at 1-800-274-8995.
- 4) If no signal is found, increase the elevation by 1 more degree and go back to step 1. If you do find a signal, go to step 5.

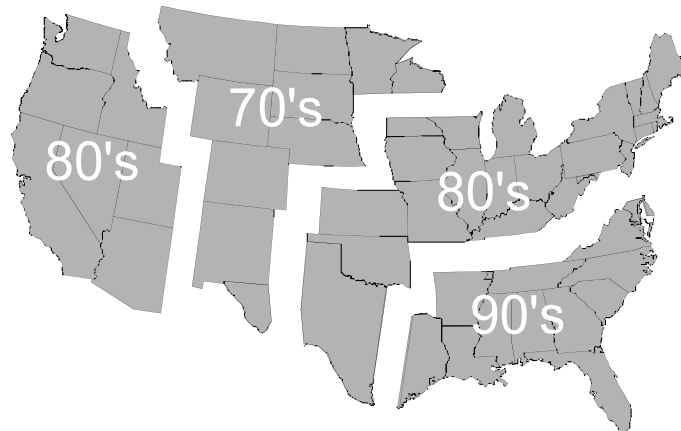

Typical signal strength results. Your actual signal strength may vary.

- 5) To have reached this step it is assumed that there is some degree of signal. A numeric value for the strength ranges from 0 to 99. While your signal strength may vary, refer to the following map to determine the suggested signal strength goal for your area:
- 6) Gently continue turning the satellite dish antenna reflector a small amount as you were turning it when you began receiving a signal. Continue to adjust the satellite dish antenna in this fashion until the signal strength meter reaches the highest possible reading. Tighten the azimuth bolts.
- 7) Slowly tilt the satellite dish antenna up and down to try to improve the signal strength reading. When you are satisfied that you have achieved the strongest signal, tighten the elevation bolts.

You may choose to try different transponders. Each transponder transmits multiple programs at a time. The transponder displayed when entering the screen represents the one associated with the last viewed program (or "02" if no program has been viewed). By moving the highlight to the transponder area, you can enter a number from 01 to 32. Different transponders may show varying signal strengths. This is not indicative of any problem unless the variations are extreme (such as 40 and 90). In the event of signal reception problems, customer service representatives may ask for information such as signal strength on a different transponder. Do not change transponders trying to find the best signal since the transponder will automatically change to the one that corresponds with the satellite channels that you view.

Authorizing Your Service

{ XE "Service providers" }To confirm that the satellite dish antenna is properly adjusted to receive signals, try to receive promotional channels from both, DIRECTV and USSB. If you can receive them, you can now arrange to receive your DIRECTV System programming 24 hours a day, 7 days a week, at the following numbers:

DIRECTV 1-800-DIRECTV (347-3288)

USSB 1-800-204-USSB (204-8772)

Subscribe to both DIRECTV and USSB to enjoy over 200 available channels of digitally delivered sports, movies, news, and family entertainment. Check with the service providers regarding details available offerings and packages.

WATCHING DIRECTV SYSTEM PROGRAMMING



This chapter will reveal many different ways to find the programs you want to watch. The first thing you should know is that channels in the DIRECTV System world are arranged differently. Channel numbers range from 100 to 999.

Basic Channel Changing

There are many ways to “surf” through the available programming. Anyone who has ever used a remote control TV already knows at least two ways to change channels. The first of these is by using the **CH** and **NO** keys. Each key press takes you to the next available channel in the direction that you selected. The second way is to enter the number of the desired channel. For example, to go to the Direct Ticket movie previews, simply press **1000**. Or to watch the USSB preview channel, press **999**. You can enter the number for any channel you wish.

The Channel Banner

{ XE "Channel Banner" } Every time you tune to a channel, a banner will be displayed at the top of the screen. You can also display the **Channel Banner** any time by pressing the **INFO** key. Pressing **EXIT** will remove the banner immediately.

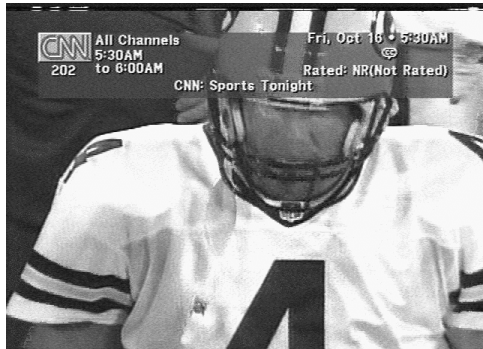

The CHANNEL BANNER

This banner contains information about the program, including the program start and end times, title, rating, channel call sign or logo, channel number, and program or channel-related symbols where applicable. Symbols { XE "Icons" } { XE "Symbols" }, as shown below, could include alternate audio, data, new mail, can't tape, closed caption, and/or the lock status. See the section called “Alternate Services” later in this chapter for information on accessing alternate audio or data services.

The Information Banner

Pressing the **INFO** key a second time while the **Channel Banner** is displayed will replace the information with any available description of the current program. This is called the **Information Banner**. Either of these banners will go away after a few seconds, or you can press the **INFO** key or **EXIT** key to clear it on demand.

Icon	\$	DATA SVCS.	ALT. AUDIO	CC	NEW MAIL	🔒	🔓	CAN'T TAPE
Meaning	Pay Per View	Data available	Other audio available	Closed caption available	Unread mail	Limits enforced	Limits override	Taping not allowed

Additional information displayed in the banner includes the current date and time, and current favorite list.

The OneLine™ Guide

{ XE "Browse Banner" } If you'd like to know what's on another channel without switching from your current channel, use the **OneLine Guide**. Simply press **▲** or **▼** and begin browsing. You can see the channel call sign and number, titles, and program start and end times. When you see something you like; then press **SELECT** to tune to the channel.

You may also directly enter a channel number to advance the **OneLine Guide** to that channel. The other filter keys, including **ACTION 1**, **ACTION 2**, and **ACTION 3**, as well as the **FAV** key will also control the content of the OneLine Guide.

Pressing the **EXIT** key will cancel the **OneLine Guide**.

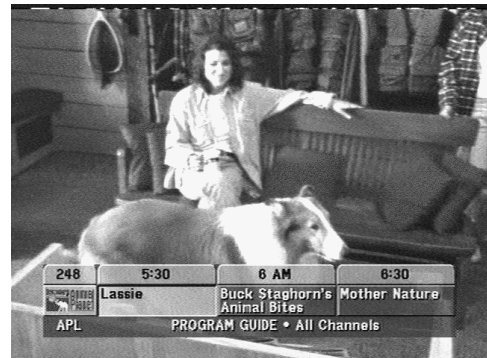

The OneLine Guide

TurboTune™

The **TurboTune** feature provides access to nine of your preferred channels on top of the current video.

The **TurboTune** panel is displayed by pressing the **SELECT** key while watching video as long as there are no messages prompting you to press **SELECT** for some other purpose. The **TurboTune** panel displays nine channel tags. These channels can be specified via the **TurboTune** button on the **SETUP MENU**. The header area of the panel displays the title of the program currently airing on the highlighted channel tag. You can choose one of the nine by moving the highlight over the desired channel and pressing **SELECT**. A shortcut to moving the highlight is to press the remote control numbers that corresponds with the on-screen position of the desired channel. In the example on the right, press 7 for HBO.



The TurboTune panel

AlphaTune™

AlphaTune enables you to tune to a channel by spelling a channel's call sign rather than by number. To enter the AlphaTune mode, you must first press the **ALPHA** key located on the lower right on the keypad. The **ALPHA** symbol appears on the screen. You can now enter the numbers and letters (located above each of the number keys) to spell the desired channel call sign. For example, to tune to ESPN, press **ALPHA 2765**. All special symbols (i.e., &, /, +, !, etc.) are located on the **0** key. As soon as the receiver can determine which channel you are seeking, it will tune to it automatically. No additional keys need to be entered. If the channel call sign is fewer than four letters, you may need to press **SELECT** to indicate that you are finished. If more than one channel shares the same set of key (i.e., "CNN" and "COM", both using **155**), the next matching occurrence is used. If that was not the channel you wanted, just press **ALPHA ALPHA** to find the next occurrence of that key sequence. It is important that you enter the channel call sign exactly. With experience, you will become more familiar with the channel name abbreviations that are used.

Alternate Services

{ XE "Alternate Services" }The digital satellite receiver can support alternate audio and data reception.



The Alternate Services panel

To determine if the services are available for a particular program, look for their icons below the date and time in the **Information Banner** or on the on-screen guide. To access these services when available press the **ACTION** **CH** key on the remote control. The **Alternate Services** banner will appear at the bottom of the screen. Highlight and select the *Alt. Audio* to temporarily change the audio language.

Alt. Audio

{ XE "Alt. Audio" } { XE "Alternate Services:Alt. Audio" }Once you have selected the *Alt. Audio* button you can use the ▲ and ▼ keys to step through the audio tracks offered for the current program. To choose the highlighted language, press **SELECT**. On occasion an audio track may be offered that is not being broadcast. If this is the case for

the selected track, the audio you hear will either be unchanged or silent.

Changing channels will restore the audio track to the one that is specified on the **PREFERENCES** screen. See the chapter “The Digital Satellite Receiver’s Menu System” for information on setting the default audio.

THE ON-SCREEN GUIDES

6

{ XE "PROGRAM GUIDE:overview" }The most powerful feature of the digital satellite receiver is the on-screen guides. You may customize the on-screen guide you can see a page of channels or program listings to include only programs of interest to you. Other advanced features available from the on-screen guides, such as scheduling and program information, will help plan your viewing. Continue reading to learn the real power of the digital satellite receiver's on-screen guides. At any time you can press the **GUIDE** key to display the current on-screen guide.

This digital satellite receiver offers a variety of on-screen guides. Each guide has its own design to make finding programs of interest an easy task. These guides include the **PROGRAM GUIDE (SM.CELL)**, **PROGRAM GUIDE (LG. CELL)**, **TITLE GUIDE**, **LOGO GUIDE**, and **WATCHWORD™ GUIDE**.

Each guide can be filtered into smaller channel groupings, as specified in your personalized favorite *Channel Lists*. You can also reduce the displayed listing by specifying a *Theme* of interest, and then narrow the offerings further by specifying a type within the *Theme*. Additional settings, such as *Guide Times* and *Classes*, may be specified to determine the guide content. A full description of the filtering options can be found later in this chapter.

Choosing the Guide Style

To display on-screen guides, press the **GUIDE** key. Press the **GUIDE** key again to display or remove the guide pop-up menu. The guide menu provides buttons to access the **MAIN MENU**, exit to *Video*, ways to narrow your search, and *Guide Style*.

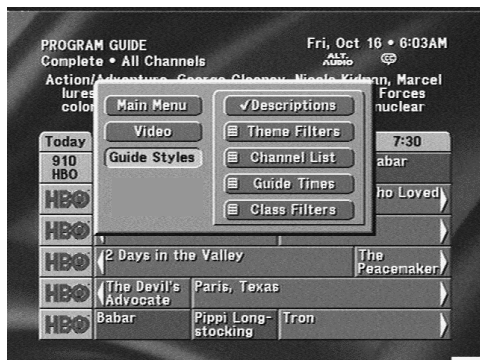

The Guide pop-up menu

To choose a guide style, simply highlight the *Guide Style* button and press **SELECT**. A pop-up menu offering each of the guide styles will be displayed. Highlight your selection and press the **SELECT** key. The guide will be redrawn to display your selection.

Descriptions

One guide option is to automatically display descriptions for highlighted program titles. The descriptions usually provide information such as actors' names, a program synopsis, and additional rating information. Sometimes the description may be only a message describing what type of program is highlighted, such

as "Current News."

This option is chosen via the *Descriptions* button on the guide pop-up menu. Displaying the extra information reduces the number of channels or titles that can be displayed at one time.

Remember that you can always access program descriptions by pressing the **INFO** key, whether or not the *Descriptions* button is selected.

General On-Screen Guide Features

While there are nine different ways the on-screen guide can appear, there are some things they have in common.

The guide name will always appear in the upper left corner. It may be something simple like "PROGRAM GUIDE." If you have filtered the guide, it could be more descriptive such as "COMEDY MOVIES GUIDE." (See "Filtering the Guides" section later in this chapter.)

- Immediately below the guide title are indicators showing how the guide is further filtered. The label to the left of the bullet specifies the current class filter setting. To the right of the bullet you will see the current channel list.
- In the upper right corner of your screen the current day, date, and time are displayed.
- Just below the time you may see small icons indicating the status of the system or details about the currently highlighted program title. They are the same icons that can appear in the **Channel Banner**.
- The primary body of the guide screen displays channels or program titles. You can press **SELECT** on a currently airing program to tune to it. Pressing **INFO** will take you to the **INFORMATION** screen described later in this chapter in the section called "Getting Program Information."
- If a program title cannot entirely fit in the space provided, an ellipsis (...) indicates that a portion of the title is missing.

Using PreSelect to Schedule Programs for Taping

This feature is commonly known as StarSight One-Touch Record (OTR). With the PreSelect feature you can select viewing choices in advance to avoid missing them. Use PreSelect to plan your evening viewing; your DIRECTV System will automatically change channels according to your selections and control your VCR for unattended recording.



To PreSelect a program, find an upcoming program you wish to watch. Press **SELECT** to add a PreSelect to Tape entry to the **SCHEDULER** screen which holds all scheduled events. Programs that have been scheduled to be taped will be identified with a videotape icon (📼) before the program title on the on-screen guide.

When using the *Schedule To Tape* feature the following steps must be completed for the digital satellite receiver to perform unattended recording:

- Attach the VCR Control cable as described in the chapter "Setting Up Your DIRECTV System."
- Use the **VCR SETUP** screen as described in the chapter "Your Digital Satellite Receiver's Menu System."
- Set your VCR to match the output of the digital satellite receiver. This could be either RF (channel 3 or 4) or A/V (phono or S-video).
- Insert a recordable videotape of sufficient length in the VCR.
- Leave the VCR turned ON.

Using PreSelect™ to Schedule Programs for Viewing

If you do not want to have the PreSelected program recorded, press the **SELECT** key again to change the setting to be automatically tuned to for viewing. Programs that are PreSelected for viewing will be identified on the on-screen guide with a check mark (✓) before the program title. An additional press of the **SELECT** key will return the status to not scheduled.

The PROGRAM GUIDE (SM. CELL)

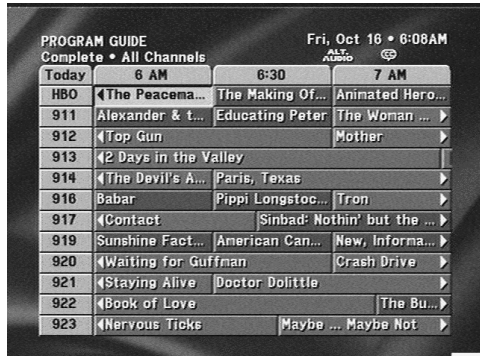

The PROGRAM GUIDE (SM. CELL) without descriptions

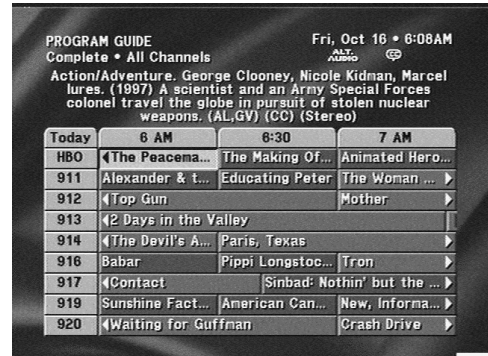

The PROGRAM GUIDE (SM. CELL) with descriptions

The **PROGRAM GUIDE (SM. CELL)** displays 1_-hours of programming. Up to 12 channels can be seen at one time. This number is reduced to 9 if the program description option is enabled.

The largest area of the **PROGRAM GUIDE (SM. CELL)** made up of cells is known as the program grid. Some cells have arrows indicating that the program started at an earlier time or continues until a later time than displayed in the grid. Each grid cell approximates the duration of the associated program.

A time line spanning the width of the guide indicates the show times of the programs being displayed. The list of blocks running down the left-hand side are the “channel tags.” Depending on the *Channel Sort* (Name or Number) option specified in your system’s **PREFERENCES** screen (described in “The Digital Satellite Receiver’s Menu System”) the tags may display the channel numbers or call signs. This will dictate whether the channels are listed by channel number or alphabetically by call sign.

{ XE "PROGRAM GUIDE:Moving around" }To navigate the guide, use the ▲, ▼, ◀, and ▶ keys. You can continue to press the ▲ or ▼ keys to scroll more program offerings onto the screen.

Pressing **INFO** on any title will direct you to the **INFORMATION** screen.

Use **FN** and **CV** to scroll through the guide entries a full page at a time.

When the highlight is in the grid, use the ◀ and ▶ keys to move left and right. If you move the highlight onto the channel tags, they will temporarily change to the opposite of what they were before (either channel numbers or call signs).

Move the highlight to the right to move the grid area to reveal later time periods. Sometimes, after scrolling a few hours ahead, there may be a brief delay while more information is received from the satellite.

The PROGRAM GUIDE (LG. CELL)

Today	6 AM	6:30	7 AM	7:30
241 HIST	The Great Ships		Year by Year for ...	Inspector Gadget's ...
The Disney Channel	Mickey's Mouse Trac...	Chip 'N Dale's Res...	Aladdin	Timon & Pumbaa
The Disney Channel	Brink!		Disneyland, U.S.A.	
244 TDIS		What-A--Mess	Hello Kitty ...	Gummi Bears
Discovery 3	Paid Programming	Paid Programming	Paid Programming	Paid Programming
Discovery 3	Rory's Place	Salty's Lighthouse	The Berenstain Bears	Pappyland
Discovery 3	Josee and the Pussyc...	Flintstone Kids	2 Stupid Dogs	Dexter's Laboratory
Discovery 3	Buck Staghorn's Anima...	Mother Nature	Acorn: The Nature Nut	Jim Henson's Animal...

The PROGRAM GUIDE (LG. CELL) without descriptions

Today	6 AM	6:30	7 AM	7:30
241 HIST	The Great Ships "The Pirate Ships" Exploration of pirate ships.		Year by Year for ...	Inspector Gadget's ...
The Disney Channel	Mickey's Mouse Trac...	Chip 'N Dale's Res...	Aladdin	Timon & Pumbaa
The Disney Channel	Brink!		Disneyland, U.S.A.	
244 TDIS		What-A--Mess	Hello Kitty ...	Gummi Bears
Discovery 3	Paid Programming	Paid Programming	Paid Programming	Paid Programming
Discovery 3	Rory's Place	Salty's Lighthouse	The Berenstain Bears	Pappyland
Discovery 3	Josee and the Pussyc...	Flintstone Kids	2 Stupid Dogs	Dexter's Laboratory
Discovery 3	Buck Staghorn's Anima...	Mother Nature	Acorn: The Nature Nut	Jim Henson's Animal...

The PROGRAM GUIDE (LG. CELL) with descriptions

The **PROGRAM GUIDE (LG. CELL)** displays two hours of programming. Up to 8 channels can be seen at one time. This number is reduced to 6 if the program description option is enabled.

The largest area of the **PROGRAM GUIDE (LG. CELL)** made up of cells is known as the program grid. Some cells have arrows indicating that the program started at an earlier time or continues until a later time than displayed in the grid. Each grid cell approximates the duration of the associated program.

A time line spanning the width of the guide indicates the show times of the programs being displayed. The list of blocks running down the left-hand side are the "channel tags." Depending on the *Channel Tag* (Name/Number or Logos) option specified in the system's **PREFERENCES** screen (described in the chapter, "The Digital Satellite Receiver's Menu System") the tags may display the channel numbers and call signs or network logos. Also, the *Channel Sort* (Name or Number) option specified in the system's **PREFERENCES** screen will dictate whether the channels are listed by channel number, or alphabetically by call sign.

{ XE "PROGRAM GUIDE:Moving around" }To navigate the guide, use the ▲, ▼, ◀, and ▶ keys. You can continue to press the ▲ or ▼ keys to scroll more program offerings onto the screen.

Pressing **INFO** on any title will direct you to the **INFORMATION** screen.

Use **⏪** and **⏩** to scroll through the guide entries a full page at a time.

When the highlight is in the grid, use the ◀ and ▶ keys to move left and right. If you move the highlight onto the channel tags, they will temporarily change to the opposite of what they were before (either channel numbers or call signs).

Move the highlight to the right to move the grid area to reveal later time periods. Sometimes, after scrolling a few hours ahead, there may be a brief delay while more information is received from the satellite.

The TITLE GUIDE

Title	Time	Channel
Abundant Life	7:00AM	288 • BET
Acorn: The Nature Nut	Multiple	248 • APL
Adharm	Multiple	657 • NetA
The Adventures of Milo an...	5:40AM	228 • SZ2W
The Adventures of Pinocc...	Multiple	Multiple
After Midnight	4:45AM	941 • TMCW
Air Bud	7:00AM	228 • SZ2W
Airport '98	6:25PM	654 • ESC1
Aladdin	7:00AM	242 • DIS1
Album	1:00PM	641 • CIAO
Alcatraz: Whole Shocking ...	9:50AM	236 • TRUE
Alexander & the Terrible	Multiple	Multiple

The TITLE GUIDE without descriptions

Title	Time	Channel
Abundant Life	7:00AM	288 • BET
Acorn: The Nature Nut	Multiple	248 • APL
Adharm	Multiple	657 • NetA
The Adventures of Milo an...	5:40AM	228 • SZ2W
The Adventures of Pinocc...	Multiple	Multiple
After Midnight	4:45AM	941 • TMCW
Air Bud	7:00AM	228 • SZ2W
Airport '98	6:25PM	654 • ESC1
Aladdin	7:00AM	242 • DIS1

(1989) A cat and a dog find perils and mates after straying from their farm in Japan. Edited from the 1986 "Adventures of Chatran." (CC) (Stereo)

The TITLE GUIDE with descriptions

The TITLE GUIDE

displays up to 12 program titles at any one time. This quantity is reduced to 9 if the program description option is enabled.

The largest area of the **TITLE GUIDE** is the first column that displays the program titles in alphabetical order. If a program title cannot fit entirely, an ellipsis (...) indicates a portion of the title is missing. The second column indicates the start time of the program. If the program is going to be airing several times within the next few hours, the word "Multiple" will appear in this column. The third column indicates the program channel. If the program is going to be airing on several different channels, the word "Multiple" will appear in this column. Pressing **INFO** on any title will direct you to the **INFORMATION** screen where you can select *Show Times* to determine which showings best suit you.

{ XE "PROGRAM GUIDE:Moving around" }To move around the guide, use the ▲ or ▼ keys. You can continue to press the ▲ or ▼ keys to scroll more program offerings onto the screen.

To speed up the process of reviewing the guide, you can use **FN** or **FV** to page through the guide entries a full page at a time.

The LOGO GUIDE

The LOGO GUIDE without descriptions

TNT: Charlie's Angels
"The Killing Kind" The Angels probe the murder of a reporter who was on the trail of a shady resort-developer (Robert Loggia); guest Hal Needham.

The LOGO GUIDE with descriptions

The LOGO GUIDE

displays up to 56 network logos at a time. This number is reduced to 42 if the program description option is enabled.

The title of the program currently airing on the highlighted channel appears in the header area immediately above the logo grid. Only current programming is available from the **LOGO GUIDE**.

{ XE "PROGRAM GUIDE:Moving around" }To navigate the guide, use the ▲, ▼, ◀, and ▶ keys. You can continue to press the ▲ or ▼ keys to scroll more program offerings onto the screen.

Pressing **INFO** on any title will direct you to the **INFORMATION** screen.

Use **⏪** and **⏩** to scroll through the guide entries a full page at a time.

The WATCHWORD™ Guide

The **WATCHWORD** guide lists programs matching one of the eight words you have specified on the **WATCHWORD** screen (accessed from the **SETUP MENU**).

The **WATCHWORD** guide displays up to 8 program titles that can be seen at once. { XE "PROGRAM GUIDE:Moving around" }To navigate the guide, use the ▲ or ▼ keys. You can continue to press the ▲ or ▼ keys to scroll more program offerings onto the screen.

The first column displays the program titles. The second column indicates the start time of the program. The third column indicates the channel that the program is or will be airing on. The fourth and final column indicates the keyword that was found in the program title

WATCHWORD GUIDE			
Complete • All Channels			
Title	Time	Channel	Word
House Doctor	Today 6:30AM	214 HGTV	DOCTOR
Doctor Dolittle	Today 6:30AM	5 WMTIME	DOCTOR
Animal Doctor	Today 11:00AM	5 WMTIME	DOCTOR
Ask the Family Doctor	Today 1:00PM	5 WMTIME	DOCTOR
Animal Doctor	Today 2:00PM	5 WMTIME	DOCTOR
Doctor Dolittle	Today 2:45PM	5 WMTIME	DOCTOR

The WATCHWORD Guide

Pressing **INFO** on any title will direct you to the **INFORMATION** screen.

To speed up the process of reviewing the guide, you can use **⏪** or **⏩** to page through the guide entries a full page at a time.

Filtering the Guides

{ XE "PROGRAM GUIDE:Filtering" }Searching through hundreds of programs can be overwhelming. The digital satellite receiver will help you find what you are looking for. By pressing the **GUIDE** key while already in a guide, a pop-up menu will display, providing the filtering tools and ways to access other guide styles.

By combining each of these filter options, you can quickly narrow down 200+ channels to those that meet your viewing interests. Once you exit to view your program, all filters except for the favorite list will reset to an unfiltered condition.

You should also be aware that some guide styles do not provide access to certain filter options. The unavailable filters will not appear in the Guide Menu.

Theme Filters

{ XE "Categories" } { XE "PROGRAM GUIDE:Category" }When the *Theme Filters* button is highlighted and **SELECT** is pressed, a pop-up menu appears. This menu offers all the available category groupings of programs. After choosing a category (other than *All*), the drop-down menu is replaced by another menu called Types.

PROGRAM GUIDE			
Complete • All Channels			
Today 6 AM		7:30	
248 APL	Buck Staghorn's Anima...	ne ut	Jim Hensorri's Anima...
	SIGN OFF		Rocko's Modern Li...
	The Wonder Years		I Love Lucy
	St. Elsewhere		
	Paid Programming	amming	Denise Austin's D...
		Workout	
		Bloomberg Information Television	

Categories pop-up menu:

- Categories
- ▼ All
- Movies
- Sports
- Specials
- Series
- News
- Shopping

The Category pop-up menu

{ XE "Types" } { XE "PROGRAM GUIDE:Type" } The Types pop-up menu allows you to break down your chosen theme by type. For example, if you chose *Movies* for the category, you can now choose a type of movie such as *Comedy*, *Drama*, *Sci-Fi*, etc. After selecting one of these, the guide will be further filtered to show only those channels offering programs of the selected category and type.

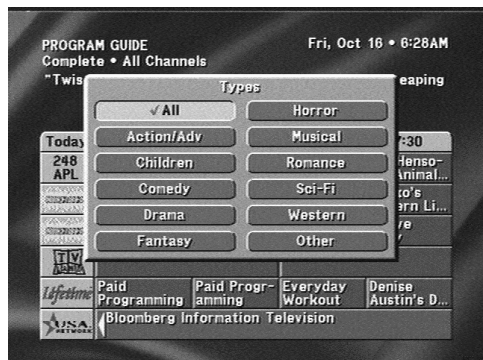

The Types pop-up menu

Popular categories can be quickly selected from your remote control by pressing **ACTION** followed by a number key. You will see labels on the remote control for filtering the guide to movies, sports, news, and all. Press **ACTION 1** for movies, **ACTION 2** for sports, or **ACTION 3** for news and the guide will filter accordingly. Pressing the key sequence a second time or pressing **ACTION 0** will restore the guide to show all themes.

Channel List

{ XE "Lists" } { XE "PROGRAM GUIDE:List" } The Lists pop-up menu enables you to filter the guide to display only channels from the selected list. In addition to *All Channels*, you can choose one of your own defined lists. See the "Fav. Lists" section of "The Digital Satellite Receiver's Menu System" to learn how to set your favorite lists.

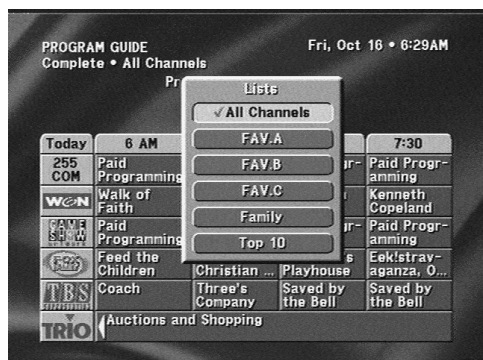

The Lists pop-up menu

You can use the **FAV** key to cycle through the lists at any time in the on-screen guide without using the drop-down menu. The *Top-10* list can only be selected via the drop-down menu.

The "Top 10" favorite list is automatically maintained by the digital satellite receiver. The digital satellite receiver monitors the channels viewed in your household and compiles the ten most watched channels on the list. As viewing habits change, the list will update itself accordingly.

It should be noted that all channel lists are maintained privately within the digital satellite receiver for your use only.

Guide Times

{ XE "Guides" } { XE "PROGRAM GUIDE:Guide" } The *Guides* pop-up menu ordinarily provides easy access to future programming information. Simply select one of the hour offsets from the current time. After a few seconds, the selected guide will appear.

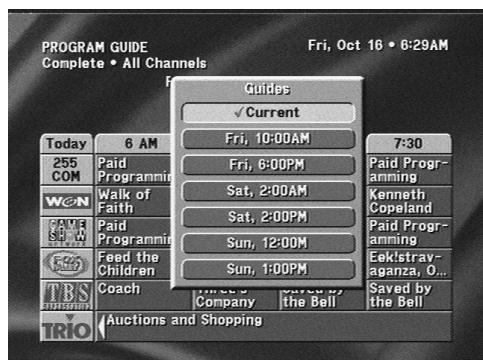

The Guide Times pop-up menu

Another type of guide that may be offered is a list-type guide. These guides do not represent channels and time, but rather a list of possible options. These guide types are very rare.

Class Filters

{ XE "Classes" } { XE "PROGRAM GUIDE:Class" } Another way to filter the guide is by using the *Classes* menu. From this menu you can select classifications including the following:

- *Subscrip* will exclude the PPV channels from the on-screen guide.
- *PPV* will list only channels offering PPV programs.
- *Schedule* will list channels that have events you have scheduled.
- Other options may be listed since the service providers can update this list via the satellite.

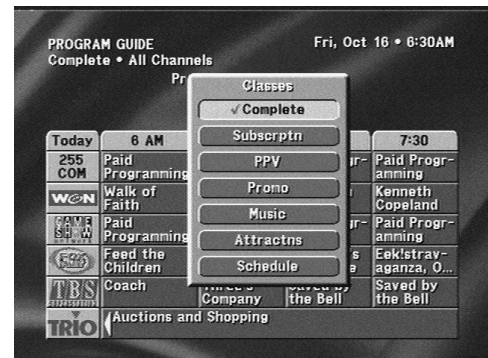

The Classes pop-up menu

The INFORMATION Screen

To obtain more information about a particular program while viewing one of the various on-screen guides, press the **INFO** key.

{ XE "Information:from the Information screen" } { XE "INFORMATION screen" } The **INFORMATION** screen offers the same program description explained earlier, and more. You can see displayed the program's actual start time and duration, the program rating, and a variety of options associated with the selected program.

Many variations of button combinations exist. The button on the left side of the Things to Do area could be *View*, *PreSelect to View*, *PreSelect*, or *Cancel PreSelect*. The button on the right side refers to PPV programs only. Unless your receiver is authorized to make such purchases this button will not be displayed. It could be *Buy \$*, *Cancel Purchase*, or *Buy Options*.

The following buttons may be available:

Done

{ XE "INFORMATION screen:Done" } When you highlight the *Done* button and press **SELECT**, you will be returned either to the guide or to the channel offering a purchase.

View

{ XE "INFORMATION screen:View" } After reading the program description and related information, you may choose to view it by highlighting the *View* button and pressing **SELECT**. If the program is a PPV event, you may need to complete the purchase process (either on-screen or by calling your service provider) before the program can actually be viewed.

PreSelect

{ XE "INFORMATION screen:Schedule" } *PreSelect* is one of the handiest features of your DIRECTV System. You can use it to plan your evening or weekend viewing, then let the system do the rest. *PreSelect* will initiate a drop-down menu offering up to three choices: *To View*, *To Tape*, and *Don't PreSelect*.

You can perform the *PreSelect* capability from within the on-screen guides. Simply highlight the program you want schedule and press the **SELECT** key. Each press of the **SELECT** key cycles through the available options.

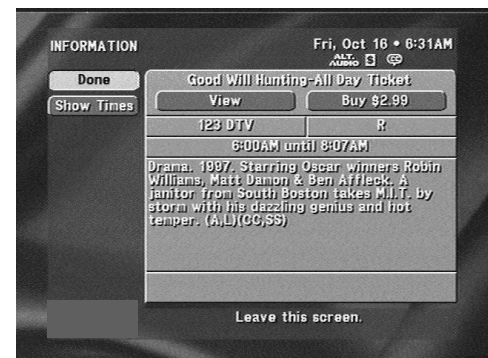

The INFORMATION screen

{ XE "Schedule:To View" } *To View* will mark the selected program to be automatically tuned in when it airs. At the right time the digital satellite receiver will turn on and tune to the appropriate channel. Your selected programs will be identified on the on-screen guide with a check mark (✓) before the program title.

{ XE "Schedule:To Tape" } *To Tape* is very similar to *To View*; however, if you have connected your VCR to the digital satellite receiver via the IR cable and have properly set the VCR code from the Setup Menu, the chosen program will be recorded at the correct time. If the digital satellite receiver turned itself on to record the program, it will also remember to turn itself back off after the program ends. Programs you have scheduled for taping will be identified with a videotape icon (📼) before the program title in the on-screen guide.

When using the *PreSelect To Tape* feature the following steps must be completed for the digital satellite receiver to perform unattended recording:

- Attach the VCR Control cable as described in the chapter “Setting Up Your DIRECTV System.”
- Use the **VCR SETUP** screen as described in the chapter “The Digital Satellite Receiver’s Menu System.”
- Set your VCR to match the output of the digital satellite receiver. This could be either RF (channel 3 or 4) or A/V (phono or S-video).
- Insert a recordable videotape of sufficient length in the VCR.
- Leave the VCR turned ON.

Don't Schedule is used if you initiate the drop-down menu and then choose not to schedule anything.

PreSelect To View

{ XE "Schedule:To View" } The *PreSelect To View* option appears when a program is not authorized for taping. In this case, the digital satellite receiver can tune to it when it airs but taping is not allowed.

Cancel PreSelect

{ XE "Schedule:Cancel" } { XE "INFORMATION screen:Cancel Schedule" } Once a program has been scheduled for viewing, previewing, or taping, you have the option of canceling the action. Schedules can also be canceled directly from the on-screen guide by highlighting a scheduled program and pressing the **SELECT** key. If you wish to switch between *To View* and *To Tape* or vice versa, you must cancel the current selection first, then choose the newly desired action. Canceling a scheduled program will also remove the check mark or videotape icon preceding the program title on the on-screen guide.

Buy \$

{ XE "Buy \$" } { XE "INFORMATION screen:Buy \$" } The *Buy \$* is used for pay per view

programming. The price of the event is displayed as part of the button. After highlighting the button and pressing **SELECT**, you will be given the opportunity to confirm your purchase.

If you are not authorized to make the purchase directly from the digital satellite receiver, you will need to contact the service provider of the event for assistance.

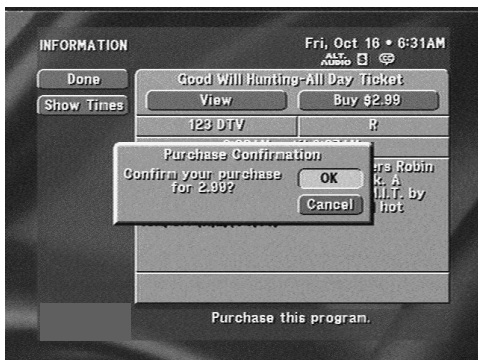

Purchase confirmation

Buy Options

{ XE "Buy Options" } { XE "INFORMATION screen:Buy Options" } The *Buy Options* button is similar to the *Buy \$* button. This button will initiate a drop-down menu with three purchase options: *View Only*, *Tape/View*, and *Don't Purchase*.

The { XE "Buy Options:View Only" } *View Only* price indicates the cost to view the program only. A purchase of this type excludes the possibility of taping the event for later viewing.

The { XE "Buy Options:Tape/View" }*Tape/View* price indicates the cost to record the event for later viewing. Of course, you can also view the event when it airs if you select this option.

After choosing either *View Only* or *Tape/View*, you may either confirm or cancel the purchase.

If neither purchase option is of interest to you, highlight { XE "Buy Options:Don't Purchase" }*Don't Purchase* and press **SELECT**.

Cancel Purchase

{ XE "Cancel Purchase" } { XE "INFORMATION screen:Cancel Purchase" } Some events may allow cancellation after they have been purchased, depending on the service provider, event type, and whether the event has been viewed. Unviewed purchases can usually be canceled. If the *Cancel Purchase* button is displayed, you are allowed to cancel the previous purchase. If this button is not offered, then most likely a portion of the event has already been viewed, committing you to the purchase.

Show Times

{ XE "OTHER TIMES screen" } { XE "INFORMATION screen:Times" } The *Show Times* button provides a simple way to display a concise list of other presentation times for a certain program. Use this button to find a more convenient viewing time.

After selecting an alternate viewing time, you will be returned to an updated **INFORMATION** screen.

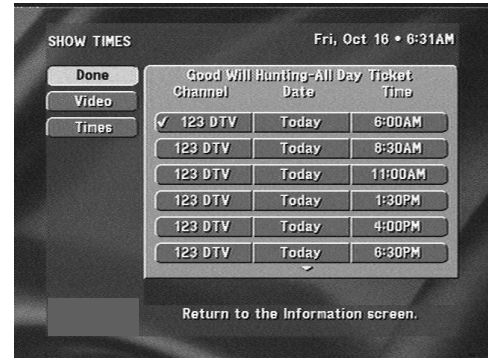

The *SHOW TIMES* screen

DIGITAL SATELLITE RECEIVER'S MENU SYSTEM



The digital satellite receiver offers much more than fantastic audio and video. The Main Menu is the primary location where you can access system management functions. { XE "MAIN MENU" }From the **MAIN MENU** you can access the on-screen guide, customize system features, read incoming messages, lock and unlock your system, and more.

Menu Overview

Digital satellite receiver menus have been designed to provide a logical and convenient way to access system features and settings. The basic screen layout of each menu is divided into several distinct areas. They are as follows:

- Title, date, and time – Across the top of the screen you will see the title of the current menu on the left-hand edge, and the date and time on the right-hand edge.
- Advisory messages – Along the bottom of the screen you will see an area that is dedicated to providing a brief explanation of the currently highlighted on-screen button.
- Places to go – Down the left-hand edge of the screen is a variety of buttons. These buttons usually navigate you to different screens. The top two buttons on the list are always *Done* and *Video*. The *Done* button will take you back one level. The *Video* button will return you to the most recently watched channel. This button is provided in case you are using the digital satellite receiver's front panel and don't have access to the remote control. If the remote control is handy, pressing the **EXIT** key is an easier way to return to your program. The information banner will appear briefly or you can erase it quickly by pressing the **EXIT** key again.
- Things to do – This largest portion of the screen is dedicated to topics associated with the current menu. Contents usually include buttons for changing settings or checking the status of some feature. You will also see information regarding the current menu.

Some buttons contain small icons inside them, indicating their function:



The current setting will cycle through the possible settings with each press of the **SELECT** key.



A list of options will be offered. This list appears in what is referred to as a "Pop-up Menu."



A series of boxes will appear used to specify numbers and/or letters for the particular feature associated with the button.

Main Menu

From the **MAIN MENU** you can access the on-screen guide, customize your system features, check incoming mail, lock and unlock your system, and more.

There are two ways to get to the **MAIN MENU**. You can press the **ACTION** **GUIDE** keys on the remote control. Or when one of the on-screen guides is displayed, you can press the **GUIDE** key to reveal another way to get to the **MAIN MENU** is by pressing **GUIDE** while the pop-up **GUIDE MENU**, then select the *Main Menu* button.

Places to go from the MAIN MENU

{ XE "MAIN MENU:Program Guide" }The *Guide* button takes you from the **MAIN MENU** to the on-screen guide. You can use the guide to display what's available at a given time. The guide also offers a pop-up menu of buttons that are useful for filtering the guide or changing the style of the on-screen guide. See the chapter "The On-Screen Guides" for detailed information.

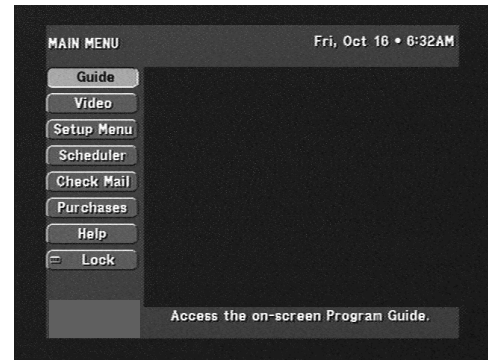

The MAIN MENU

A quicker way to access the on-screen guide from the **MAIN MENU** or any other menu is by pressing the **GUIDE** key, either on the remote control or on the digital satellite receiver's front panel.

The remaining buttons provide access to those features described in greater detail throughout this chapter.

Setup

The *Setup* button will take you to the **SETUP MENU**, which provides access to infrequently changed setup options of the digital satellite receiver.

Scheduler

The *Scheduler* button takes you to the **SCHEDULER** screen, where you can program and edit automated channel-changing events. Here, events can be programmed to occur either once or multiple times.

Check Mail

The *Check Mail* button takes you to the **CHECK MAIL** screen. The mail feature enables the service providers to inform you about upcoming special events, programming changes, offers, and other important information.

Purchases

The *Purchases* button takes you to the **PURCHASES** screen, where you can review your recent pay per view activity, including past and advance purchases.

Help

The *Help* button takes you to the **ASSISTANCE** screen. It should be your first stop when you need help or have a question. Think of this feature as a quick reference manual.

Lock/Unlock

This bottom button displays a pop-up panel to activate or deactivate the **LOCK**. It is labeled either *Lock* or *Unlock* depending on the current status of the digital satellite receiver lock. If the digital satellite receiver is locked, you will see a small lock icon just below the date and time at the top of the screen.

Setup Menu

Many functions of your digital satellite receiver can be customized. These settings may be modified and reviewed in the **SETUP MENU**.

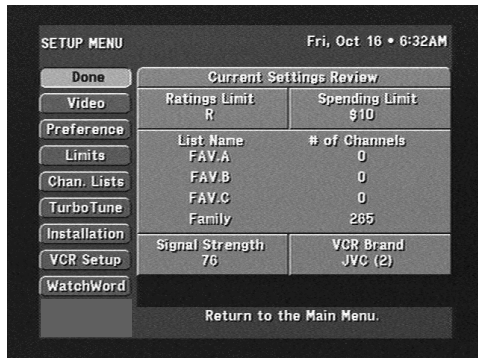

The SETUP MENU

Places to go from the SETUP MENU

The remaining buttons provide access to those features described in greater detail throughout this chapter.

Preferences

The *Preferences* button takes you to the **PREFERENCES** screen, where you can customize the appearance of the on-screen guides and various menus.

Limits

The *Limits* button takes you to the **LIMITS** screen, where you can establish restrictions on the use of the digital satellite receiver. These restrictions include program rating limits and pay per view spending limits.

Chan. Lists

The *Chan. Lists* button takes you to the **CHANNEL LISTS** screen, where you can preset your favorite channel selections into four groupings. Three lists can be named and used by different household members. A fourth list is labeled “Family” and can be used to restrict access to channels to be viewed by everyone in the household.

TurboTune™

The *TurboTune* button takes you to the **TURBOTUNE SETUP** screen, from which you may set the channels associated with the TurboTune feature. See the chapter “Watching DIRECTV System Programming” for more information on using TurboTune. Refer to the “TurboTune” section later in this chapter for information about programming the TurboTune feature.

Installation

The *Installation* button takes you to the **INSTALLATION** screen, which contains utilities to facilitate installation of your satellite dish antenna. You can also evaluate your system’s signal strength via the **INSTALLATION** screen.

VCR Setup

The *Event Setup* button takes you to the **VCR SETUP** screen, which is used to allow the digital satellite receiver to be able to perform unattended recording on a VCR. You will need to tell the digital satellite receiver what your VCR brand and the code used to control it.

WatchWord

The *WatchWord* button takes you to the **WATCHWORD** screen, which is used to specify key words in program titles and descriptions that are of interest to you. After specifying up to eight different words, the digital satellite receiver will search for program information containing one or more of these words while the digital satellite receiver is in standby mode.

Things to do in the *SETUP MENU*

Current settings overview

An overview of the current settings can be reviewed without having to access each associated screen.

Scheduler

The digital satellite receiver is equipped with a **SCHEDULER** that allows up to 32 events to be programmed. You can use the **SCHEDULER** feature along with your VCR to record programs unattended. The **SCHEDULER** can be used to automatically tune to a program at a specific date and time or at a specific time on a repeating basis.

{ XE "MAIN MENU:Event Timer" } You may choose to also program your VCR's timer to achieve unattended recording.

When using the *PreSelect To Tape* feature the following steps must be completed for the digital satellite receiver to perform unattended recording:

- Attach the VCR Control cable as described in the chapter "Setting Up Your DIRECTV System."
- Use the **VCR SETUP** utility as described in the chapter "The Digital Satellite Receiver's Menu System."
- Set your VCR to match the output of the digital satellite receiver. This could be either RF (channel 3 or 4) or A/V (phono or S-video).
- Insert a recordable videotape of sufficient length in the VCR.
- Leave the VCR turned ON.



The *SCHEDULER* screen

Things to do in the *SCHEDULER* screen

The **EVENT TIMER** screen displays up to seven rows of events. You can use the ▼ key to scroll through the events.

There are multiple settings for the *On* column: a check mark (✓) for viewing only, or a videotape symbol (📼) for taping.

Editing an event

The "Events" portion of the screen displays up to seven previously scheduled events at one time. If more than seven events are already scheduled, you may use either the ▼ key to scroll down, or the ⏮ key to view the additional events. A small arrow at the top or bottom of the event list indicates that there are additional events.

Once you have highlighted the event you wish to set or edit, press **SELECT**. You will be prompted with a pop-up menu. Your options include *PreSelect to View*, *PreSelect to Tape*, *Delete*, and *Cancel*. If you choose either of the scheduling options, the digital satellite receiver will turn on (if necessary) and tune to the specified channel at the correct date and time. If you choose the *Schedule to Tape* option and you have successfully completed the VCR setup procedure, the digital satellite receiver will allow

recording of the event. To remove a previously scheduled event, select the *Delete* option. If you inadvertently pressed **SELECT**, select *Cancel*.

After choosing one of the scheduling options, a pop-up panel appears for channel selection. You can enter the desired channel using either the number keys on the remote control or the ▲ and ▼ or **CH** and **HO**.

After specifying a channel, press the **SELECT** key or select *OK* when you are ready to continue.

Next, enter a *Start* time using either the number keys on the remote control or the ▲ and ▼ keys. Press ► to continue.

You then must specify whether the time you entered is AM or PM (or N for noon, or M for midnight if the time specified is 12:00) using the ▲ and ▼ keys. To continue, press ►.

Using the same procedure as setting the start time, set the program *Duration* as hours and minutes. As before, use ► to advance to the *Frequency* column.

The *Frequency* column is very versatile. Using the ▲ and ▼ keys, you can specify when, or how often, the event occurs. Your choices are: *Today, Tomorrow, Every Mon, Every Tue, Every Wed, Every Thu, Every Fri, Every Sat, Every Sun, Everyday, Mon-Fri*, or “/” to specify an exact date. If you are specifying a date, enter the numbers using the remote control in month/day format. The year will be set automatically. Events can be scheduled up to eleven months in advance. Once you have set the *Frequency*, advance using the ► key.

Review your settings and choose *OK*. Otherwise, choose *Cancel* to delete the edits made to this event.

Check Mail

{ XE "MESSAGES screen" } { XE "MAIN MENU:Messages" } The **CHECK MAIL** feature of the digital satellite receiver enables service providers to notify you about important information, upcoming special events, offers, and other promotional programming.

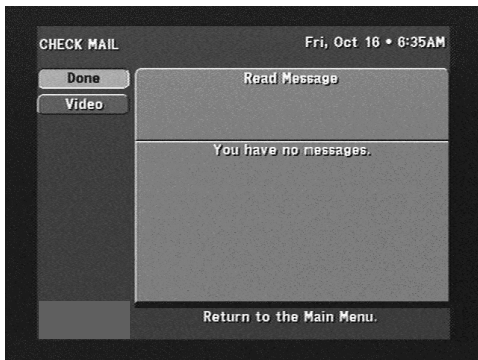

The *CHECK MAIL* screen

When new messages are received, a “new mail” icon appears at the top of all menu screens. This indicator will remain on the menus until you have read the new message.

When you highlight the *Check Mail* button, the advisory message at the bottom of the screen indicates if there are any messages to read. If there are, you can press **SELECT** to access the **CHECK MAIL** screen.

Things to do in the CHECK MAIL screen

Message

The *Message* button will allow you to cycle through multiple messages if more than one piece of mail is available. Highlight the *Message* button and use the ▲ and ▼ keys to step through the messages.

Page

The *Page* button will allow you to cycle through the pages of a multi-page message. Highlight the *Page* button and use the ▲ and ▼ keys to step through the pages.

Erase

The *Erase* button will remove a piece of mail from your mailbox. Please be aware that once a piece of mail has been erased, it cannot be retrieved. Messages will self erase if they become outdated or if space is needed to hold newer incoming messages.

Purchases

The **PURCHASE** screen displays recently viewed and advanced purchased pay per view events. You can choose between Purchase History and Upcoming Purchases by selecting the *History* button or *Upcoming* button located in the Places to Go area of the **PURCHASES** screen.

For each purchase, the event channel, title, start date and time, and cost is listed. If there are more events than can fit on the screen, use the ▼ key or advance a page at a time by pressing **HO** to view them

If you need to discuss an event with your service provider, highlight the questioned event and press the **SELECT** key. An advisory message will appear containing additional the service provider may need.

Places to go from the PURCHASES screen

History/Upcoming

The *History* or *Upcoming* button appears only on the complementary screen. This means that if you are viewing history on the **PURCHASES** screen, you will have the *Upcoming* button offered. Conversely, if you are viewing upcoming on the **PURCHASES** screen, you will have the *History* button offered in the Places To Go area.

Things to do on the PURCHASES screen

Purchase History

{ XE "MAIN MENU:*History*" }The Purchase History{ XE "PURCHASE HISTORY screen" } displays recently viewed pay per view events that will be or have been charged to you. You will not see events you purchased but later canceled, or cancelable events that were purchased but which the digital satellite receiver never tuned to, will not appear. Events that were ordered by directly calling the service provider will also not appear on this list. You cannot remove events from this list. Reported events will disappear from this list as the digital satellite receiver needs space to log more recent purchases.

You will see the event channel, title, the start date and time, and the cost for each purchase. There may be more events than can fit on the screen. You can access these by using the ▼ key or **HO** key.

If you need to discuss an event with your service provider, highlight the questioned event and press **SELECT**. Additional information will be displayed.

Upcoming Purchases

{ XE "MAIN MENU:*Upcoming*" }The Upcoming Purchases{ XE "UPCOMING PURCHASES screen" } screen displays PPV events you have purchased but not yet viewed, or purchased but never viewed. Events that were ordered by calling the service provider will not appear on this list.

You will see the event channel, title, the start date and time, and the cost for each purchase. There may be more events than can fit on the screen. You can access these by using the ▼ key or **HO** key.

If you would like to cancel an event, highlight the event in question and press **SELECT**. A pop-up panel will be displayed where you may be given the opportunity to cancel your purchase. Be aware that cancellation of some events may not be possible.

Lock/Unlock

{ XE "MAIN MENU:Lock" } When you first receive your satellite system, it will be unlocked; (i.e., no limits or restrictions are in effect). To enforce the limits (spending, ratings, and “Family” favorite list), you must lock the system.

When the button on the MAIN MENU reads *Lock*, no lock symbol appears at the top of the menu screen, indicating that the system is unlocked.

NOTE: Once the digital satellite receiver is locked, only existing *Family* list channels will be accessible. If the *Family* list has not had channels added to it, no channels can be viewed without first unlocking the digital satellite receiver. To avoid this inconvenience, verify the contents of the *Family* list before locking the digital satellite receiver.

Locking Procedure

When the *Lock* button is selected, the **LOCK SYSTEM**{ XE "LOCK SYSTEM screen" }{ XE "LOCK SYSTEM" \t "also see *Unlock*" } pop-up panel is displayed. Use the ▲ and ▼ keys or the remote control number keys to enter a four-digit passcode of your choosing. If you enter the code using the number keys, you will not see the numbers appear on the screen. After entering a four-digit passcode, highlight and select *OK* to proceed. Otherwise, choose *Cancel* to cancel the locking process.

If you continue, you will be asked to confirm the code by entering it again in the same fashion as before. Once again, highlight and select *OK* to proceed. Otherwise, choose *Cancel*.

Once *OK* has been selected, the digital satellite receiver is locked. The button previously used to lock your system is now used to unlock your receiver. A lock symbol appears at the top of every menu screen to remind you that the digital satellite receiver is locked.

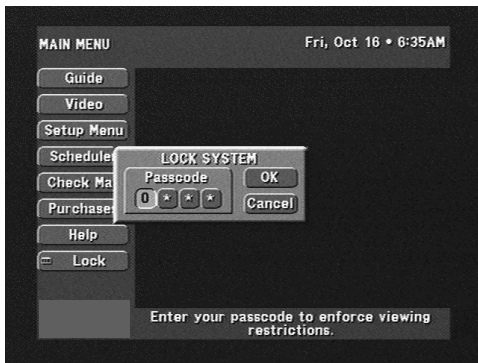

The *LOCK* pop-up panel

REMEMBER YOUR CODE! You will need this code whenever you wish to override the lock or to unlock the digital satellite receiver.

Unlocking Procedure

{ XE "MAIN MENU:Unlock" }{ XE "Unlock" \t "See SYSTEM UNLOCK" } To remove the lock and its restrictions, highlight the *Unlock* button and press the **SELECT** key.

When the **SYSTEM UNLOCK**{ XE "SYSTEM UNLOCK screen" }{ XE "SYSTEM UNLOCK" \t "also see *Lock*, and *Lock Override*" } pop-up panel appears, you can use the ▲ and ▼ keys or the remote control number keys to enter the four-digit passcode that you used to lock the digital satellite receiver earlier. If you enter the code using the number keys, you will not see the numbers appear on the screen.

After entering the passcode, highlight and select *OK*. **Once the digital satellite receiver has been unlocked, all limits and restrictions are removed!** Otherwise, choose *Cancel* to keep the lock in effect.

If you forget your four-digit code, call your service provider for assistance.

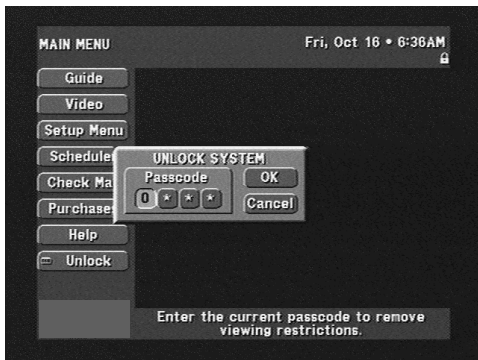

The *UNLOCK* pop-up panel

Temporarily Overriding the Lock

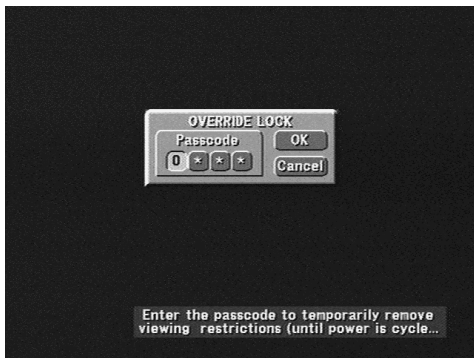

The LOCK OVERRIDE pop-up panel on video

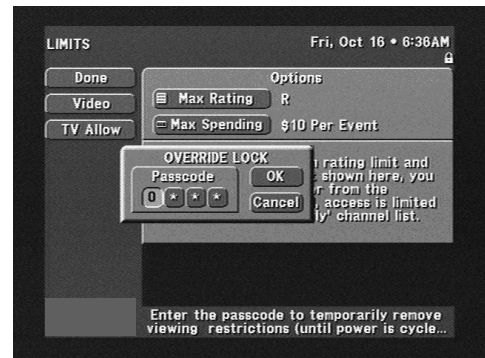

The LOCK OVERRIDE pop-up panel on menus

{ XE "LOCK OVERRIDE screen" } There are times you may wish to temporarily remove the restrictions imposed by locking. You can do this without unlocking the digital satellite receiver. When you press **SELECT**, when prompted, the **LOCK OVERRIDE** pop-up will be displayed. It looks and navigates just like the **SYSTEM UNLOCK** pop-up.

Note: Once the correct four-digit code is entered, the digital satellite receiver will remain unlocked until you power the digital satellite receiver off. At that time all locks and limits will be enforced again.

Preferences

{ XE "PREFERENCES screen" } By changing the various options on the **PREFERENCES** screen, you can customize the digital satellite receiver to operate in the way that best suits your needs.

You can access the **PREFERENCES** screen at any time and as often as you like to change any of these settings. Making changes cannot harm your DIRECTV System in any way.

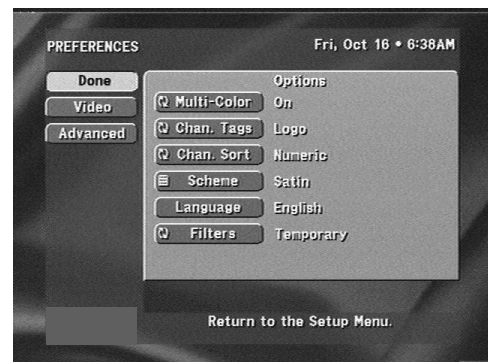

The PREFERENCES screen

Places to go from the PREFERENCES screen

Advanced

When you select *Advanced*, the **ADVANCED PREFERENCES** screen will be displayed. Here, you can set options including your digital satellite receiver ID, preferred data port, phone prefix, and screen ration. You can also reset all options to the factory default settings.

Things to do in the PREFERENCES screen

MultiColor

The *MultiColor* option allows you to choose whether or not programs in the on-screen guide will be color coded to indicate their category. When enabled, programs that are movies will appear on a rose background, sports on a green background, and news on a brown background. All other program categories will continue to appear on a blue background.

Chan. Tags

The *Chan. Tags* option will influence only the appearance of the **PROGRAM GUIDE** styles. With this control, you may choose whether the channel tags will appear as channel numbers and call signs or as network logos.

Chan. Sort

By default, "Channel Sort Option" is set to *Number*. This numerically lists channels in the program guide. Setting this option to *Name* will display channels in alphabetical order.

NOTE: If you sort the channels by *Name*, please take note. Using the **⏪ and **⏩** keys to step through the channels will appear to change channels a random order when, in fact, the channels are sorted and tuned to in alphabetical order.**

Scheme

{ XE "SETUP MENU:Default Audio" }The **SCHEME** pop-up menu enables you to select a color scheme for your on-screen guides and menus.

Language

{ XE "SETUP MENU:Default Audio" }The **DEFAULT LANGUAGE** pop-up menu enables you to specify the language track for programs you watch. While *English* is the default language, you may choose an alternate language. If your chosen language is available for the program, you will hear it in that language. Otherwise, you will hear will be the primary language in which the program produced.

Filters

{ XE "SETUP MENU:Default Audio" }The default setting for *Filters* is "Temporary." With a setting of "Temporary," each time you leave the on-screen guide, all filters other than Channel List will reset (all categories and complete class). If you change the *Filters* setting to "Persistent," any filtering that you should happen to do will survive exiting the on-screen guide and be in effect for the **OneLine Guide** and even later when returning to the on-screen guide at a later time.

Advanced Preferences

The **ADVANCED PREFERENCES** screen contains options that are less likely to require changes once they are set. Most users will not make any changes to this screen. This screen also provides a means to reset all preference options to the factory defaults.

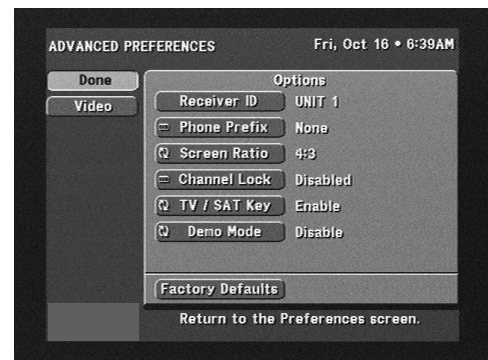

The ADVANCED PREFERENCES screen

Things to do in the ADVANCED PREFERENCES screen

Receiver ID

{ XE "SETUP MENU:Default Audio" }Someday, you may choose to get a second digital satellite receiver. If both receivers are in the same room or if you are using an RF remote control or a remote control extender, you may experience interference between signals. To avoid this “cross talk,” simply highlight the *Receiver ID* button and press **SELECT** on the remote control to be used for that specific digital satellite receiver. Remember to set your remote control to the desired code first. For information regarding changing the remote control code, see the chapter “Programming Your Remote Control.”

Phone Prefix

{ XE "SETUP MENU:Default Audio" }In some installation environments you may need to dial a *Phone Prefix* to access an outside line. Commonly this is either an 8 or a 9. You may specify up to 3 digits.

Note: This is NOT the first three digits of your telephone number or area code and should be left as “- - -” if you do not need to dial numbers to obtain an off-site dial tone.

Screen Ratio

{ XE "PREFERENCES screen:Picture Size" }*Screen Ratio* should be set to 4:3 for most televisions, which is the default. This indicates that you are using a standard format television screen. However, if you have a wide-screen television, you may want to change this setting to the 16:9 option. While setting this option to the wrong format will not harm your TV, it may cause a distorted picture.

Channel Lock

The *Channel Lock* setting provides a way for you to set your digital satellite receiver to permanently stay on a specified channel. When the setting is anything other than “- - -” the digital satellite receiver will always power up on that channel and will ignore any attempts to change the channel. To allow channel changing to function again, set this option back to “- - -.”

Input Key

The *Input Key* option allows you to enable or disable the functionality of the **TV/SAT** key on your remote control. This is useful if you are not using the local TV pass through capability of your digital satellite receiver and want to avoid getting a snowy picture from inadvertent presses of the **TV/SAT** key. Please note that the pass through capability happens automatically when the digital satellite receiver is powered off.

Demo Mode

The Demo Mode is a feature that is primarily intended for in-store presentations. When enabled, the digital satellite receiver will step through a variety of features and display messages describing these features. While pressing any key will allow you to regain operation of your digital satellite receiver, this is only temporary. After several minutes of non-interaction, the demonstration will begin again. To stop the demonstration mode permanently, disable the Demo Mode via this button.

Factory Defaults

If you ever want to reset the digital satellite receiver preferences, select the *Factory Defaults* button.

Limits

The **LIMITS** screen provides settings to help you control the viewing restrictions of satellite programming. These limits, when accompanied by the **CHANNEL LISTS**, put a great degree of control in your hands.

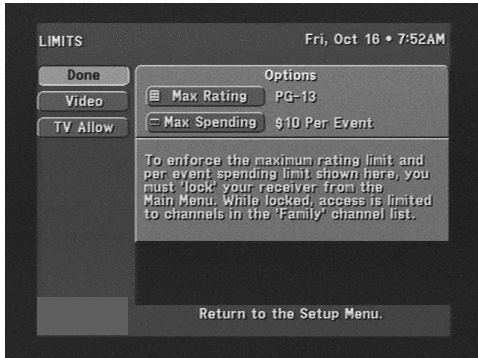

The *LIMITS* screen

Places to go from the *LIMITS* screen

TV Allow

{ XE "SPENDING LIMIT screen" } { XE "MAIN MENU:Spending limit" } When you select *TV Allow*, the **TV ALLOWANCE** screen will be presented. If your receiver is locked, you will need to enter your passcode to access this screen.



The *TV ALLOWANCE* screen

From the **TV ALLOWANCE** screen you can specify the hours that satellite programming can be viewed on your receiver. This is done by highlighting each of the days you wish to control and pressing **SELECT**. After selecting a day of the week, you can set an acceptable start and end viewing period *or* a total viewing duration.

For the TV allowance to be enforced, the digital satellite receiver must be locked, as described earlier in this chapter.

Things to do in the *LIMITS* screen

Max Rating

{ XE "RATINGS LIMIT screen" } { XE "MAIN MENU:Ratings Limit" } Program ratings indicate the suitability of a program's content for a given audience. For families with younger children, a lower rating limit may be desirable. Other families may choose to allow viewing of more sophisticated programming. The **LIMITS** screen leaves this choice and control up to you.

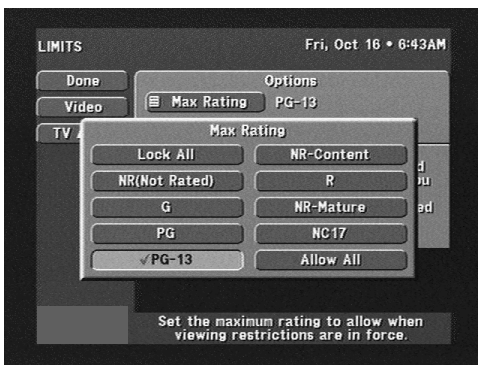

The *RATING pop-up panel*

Highlight the *Max Ratings* button and press **SELECT** to display the **MAX RATING** pop-up menu where you set the limit. When the digital satellite receiver is locked, the passcode must be entered to change the ratings limit.

Determine the highest allowable rating for your family and highlight it. When you press **SELECT** all ratings up to and including the chosen rating will be checked. All higher ratings will be cleared. You may choose to *Lock All* or *Allow All* instead of setting a specific limit.

For the rating limit to be enforced, the digital satellite receiver must be locked. Locking is described earlier in this chapter.

Max Spending

{ XE "SPENDING LIMIT screen" } { XE "MAIN MENU:Spending limit" } PPV access enables you to purchase special, limited-broadcast events such as sporting events and movies. You can set the maximum purchase price on a per-event basis. To change the displayed limit, highlight the *Max Spending* button and press **SELECT** to display the **SPENDING LIMIT** pop-up panel. When the digital satellite receiver is locked, the passcode will be needed to change the ratings limit.

Use the number keys on the remote control to set the limit or use the **▲** and **▼** keys to increase or decrease each digit. Use the **◀** and **▶** keys to highlight the digit that you want to change. The maximum limit is \$655.

Highlight *OK* and press **SELECT** to confirm the entered amount. Selecting *Cancel* will leave the spending limit unchanged.

For the spending limit to be enforced, the digital satellite receiver must be locked as described earlier in this chapter.

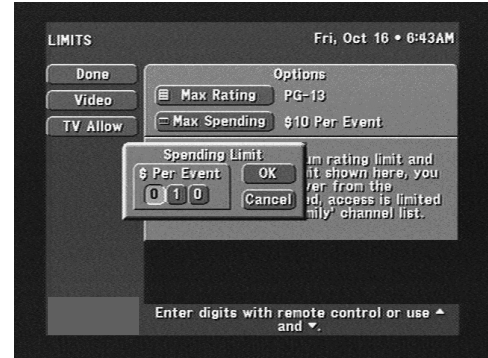

The RATING pop-up panel

Channel Lists

Channel Lists are provided to help you organize the hundreds of available channels into groupings that suit the needs of your household. Each list can contain as many or as few channels as you would like. { XE "MAIN MENU:Fav. Lists" } You can customize these groupings in a variety of ways. For example, *Fav. A* could be Dad's favorite channels, *Fav. B* could be Mom's favorites, *Fav. C* could be the kids' channels, and *Family* could be all channels that Mom and Dad have deemed appropriate for the entire family. Each of the lists, with the exception of *Family*, can be renamed.

NOTE: Once the digital satellite receiver is locked, only existing Family list channels will be accessible. If the Family list has not had channels added to it, no channels can be viewed without first unlocking the digital satellite receiver. To avoid this inconvenience, set up the Family list before locking the digital satellite receiver.

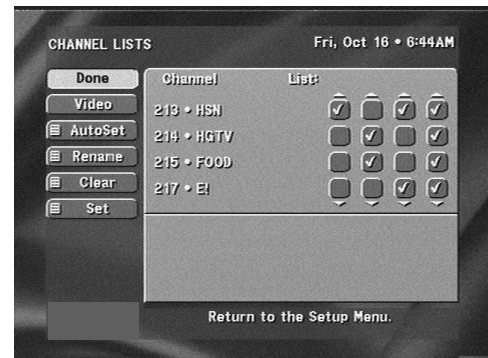

The CHANNEL LISTS setup screen

Places to go from the CHANNEL LISTS screen

Rename

{ XE "SETUP MENU:Default Audio" } When you highlight the *Rename* button and press the **SELECT** key, a Rename List pop-up menu appears. You can choose any of the first three lists to be renamed. The *All*, *Family*, and *Top 10* lists cannot be renamed. Once you have selected a list, a Rename List entry keyboard pop-up panel appears. You can highlight the desired letter using the **▲**, **▼**, **◀**, and **▶** keys. Press **SELECT** to enter the letter. When you have finished, choose *OK*.

Auto Set

AutoSet is designed { XE "SETUP MENU:Default Audio" } to help in the initial programming of your channel lists. When you select the *Auto Set* button, a pop-up menu appears showing each of the channel lists. Highlight and select a channel list to be programmed. Once selected, the Auto Set Progress pop-up status panel appears. It will take several minutes for the digital satellite receiver to scan through all channels and determine which ones you are authorized to receive. The results of this scan will be stored in the designated channel list.

Note: Auto Set may exclude some channels such as the Music Choice channels or include some pay per view channels. This does not mean that the digital satellite receiver is faulty. These channels were excluded or included due to the digital satellite receiver's analysis process. You may edit the lists manually to correct these oversights.

Clear

{ XE "SETUP MENU:Default Audio" } You may decide to remove all channels from a particular list later on. Selecting *Clear* will allow you to clear all channels from a chosen list. You may then add channels back in.

Set

{ XE "SETUP MENU:Default Audio" } If you decide to include all channels in a particular list, selecting *Set* will allow you to specify the list. You may then remove channels from this list if you so choose.

Things to do in the CHANNEL LISTS screen

Tag Boxes

The four columns of small boxes on the right hand side of the screen are the Tag Boxes. The first three columns are the lists traditionally known as *Fav.A*, *Fav.B*, and *Fav.C*. The farthest right hand column is the *Family* list.

In the CHANNEL LISTS screen, use the ▲, ▼, ◀, and ▶ keys to highlight the button that corresponds to the channel number and list that you wish to change. Press the **SELECT** key to add or remove the check mark, which indicates that the channel in that row is included in the list shown at the top of the column.

To help you decide whether to include or exclude a certain channel, the title of the currently airing program for that channel will appear at the top of the screen.

Remember that when the digital satellite receiver is locked, only channels in the Family list can be viewed. This means that even though a channel appears on the *Fav. A*, *B*, *C*, or *All Channels* list, the selected channel must also be on the *Family* list in order to see or hear it.

For the Family List limit to be in force, the digital satellite receiver must be locked. Locking is described earlier in this chapter. When the system is locked the passcode will be needed to modify the settings of the channel lists.

TurboTune™

The TURBOTUNE SETUP screen is used to specify which nine channels that will appear in the TurboTune pop-up panel that shows over video when **SELECT** is pressed.

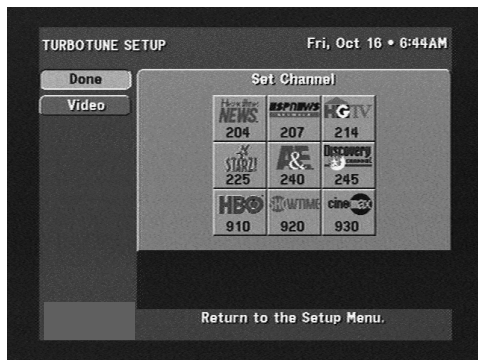

The TURBOTUNE setup screen

Things to do in the TURBOTUNE

SETUP screen

Set Channel

{ XE "MAIN MENU:Fav. Lists" } Using the ▲, ▼, ◀, and ▶ keys, highlight one of the nine channel boxes. You can enter the desired channel using the number keys on the remote control, or by using the **CH** and **CH** buttons. Pressing **SELECT** while highlighting one of the channel boxes will also initiate a pop-up panel that will allow you to set the channel using the ▲ and ▼ keys on the remote control or the digital satellite receiver's front panel.

Installation

{ XE "SETUP MENU:Dish Pointing" } The **INSTALLATION** screen provides the utilities that makes the setup and testing of your system simple and convenient.

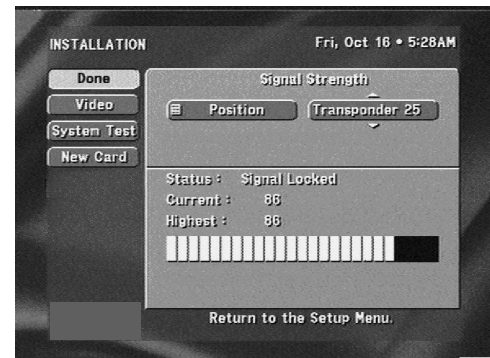

The **INSTALLATION** screen

Places to go from the **INSTALLATION** screen

System Test

The *System Test* button takes you to the **SYSTEM TEST** screen.

Things to do in the **INSTALLATION** screen

Here, the quality of the satellite signal is automatically displayed. In addition to using this at installation time, you can use it to troubleshoot if you experience loss of signal, momentary video freezing, or similar problems.

Transponder

You may want to try different transponders to troubleshoot satellite signal reception problems. Each transponder transmits multiple programs at a time. The transponder shown when the screen first displays represents the one associated with the last viewed program. By moving the highlight to the transponder area, you can enter a number from 01 to 32. Different transponders may show varying signal strengths. This is normal unless the variations are extreme (such as 40 and 90). In the event of signal reception problems, customer service representatives may ask for signal strength on a different transponder. Do not change transponders trying to find the best signal since the transponder will automatically change depending on the channel you want to view.

Another signal strength utility that you may find useful is the *Cable Test* that can be found in the **SYSTEM TEST** screen.

Position

After selecting *Position* from the **INSTALLATION** screen a pop-up menu called Alignment Mode will appear. You can enter your location by either *Align by ZIP* or *Align by LAT/LONG*. After making your selection, the appropriate pop-up entry panel will appear. Use the ▲ and ▼ keys or use the

numeric keypad to change the value of the digits. Press the ► key to advance or the ◀ key to back up. Once you have entered all of the correct digits, select *OK*. The calculated results on the proper direction to point your satellite dish antenna will be displayed.

New Card

{ XE "SETUP MENU:*New Access Card*" } { XE "Access card" } The **NEW CARD** screen { XE "NEW ACCESS CARD screen" } provides a way for service providers to distribute new access cards. Should you be issued a new card, you will need to activate it. Follow the on-screen instructions carefully to initialize it. Once the process has begun, your old access card will no longer allow viewing. You should not interrupt the process once it has begun. An interruption could cause both the old and the new card to become invalid. When the process is complete, your new access card will be usable, while the old card will no longer be valid.

System Test

Whenever you experience a problem with your satellite system, you can use the **SYSTEM TEST** screen, which runs a series of internal diagnostics that will provide you with basic information about the status of your system.

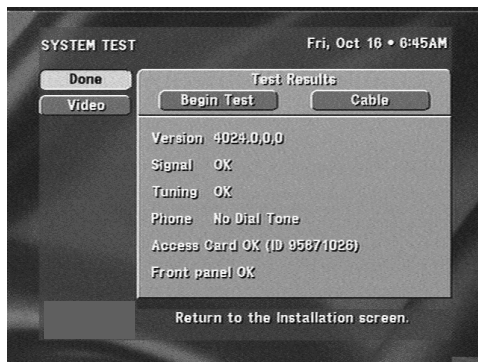

SYSTEM TEST screen

Things to do in the SYSTEM TEST screen

Receiver Test

{ XE "SETUP MENU:*System Test*" } Depending on your test results, you may be able to remedy the problem yourself. For example, if your Access Card is missing, verify that it is facing the right direction and try reinserting it. A “No Dial Tone” message indicates that the phone line is in use or the digital satellite receiver is disconnected from the phone line. If you cannot remedy a problem yourself, call your dealer or the Customer Care Center at 1-800-274-8995 and provide the technician with a complete description of the problem and the results of the system test. The technician will assist you with additional repair information and instructions.

Cable Test

When Cable Test is selected the digital satellite receiver scans through all transponders and displays the signal strength for each. If there are any detectable problems, you will be notified of the most likely cause of the problem. Otherwise, you may simply find this test to be a convenient way to analyze your signal quality.

VCR Setup

The **VCR SETUP** screen provides access to the settings that will allow the digital satellite receiver to communicate the record and stop commands to your VCR.



The VCR SETUP screen

Things to do in the VCR SETUP screen

Brand

Search through the various brands of VCRs that are supported using the ▲ and ▼ keys. Related brands that share the same control codes may be suggested. You may want to experiment with these if you are having difficulty finding a functioning code under your VCR's own brand name.

Code

More than one code may be assigned to your brand of VCR. Try each of the codes offered by using the ▲ and ▼ keys to step through each code. Alternate between this procedure and testing the code.

Test (Record/Stop)

The testing function allows you to verify that the specified brand and code will control your VCR. To run the test, the VCR Control cable must be properly attached, a recordable tape must be in the VCR and the VCR powered on.

Use the front panel of the digital satellite receiver, rather than the remote control, when testing the codes. This is because signals coming from the remote control at the same time as signals coming from the VCR Control cable could give unreliable test results.

Be sure to test both the *Record* and the *Stop* commands, which are necessary for successful taping capability. If either *Record* or *Stop* fails to function, try other *Codes* associated with your VCR brand. If you are unsuccessful in the test process after trying all available codes, recheck your VCR Control cable connections and IR emitter placement.

WatchWord

The **WATCHWORD** setup screen is used to specify up to eight different words that can be used to identify programming of interest to you. While the digital satellite receiver is in standby mode (the power light is off, but the digital satellite receiver is still connected to power) the program titles and descriptions in the guide will be searched. Programs which contain matching words, will be included in the **WATCHWORD** on-screen guide.

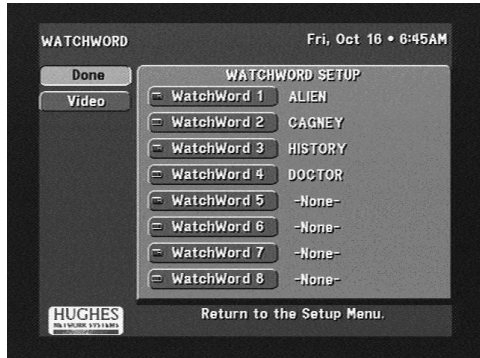

The WATCHWORD setup screen

Things to do in the WATCHWORD screen

WatchWord

Highlighting one of the eight choices and pressing **SELECT** will initiate a pop-up panel where you can define a search word. If “CAGNEY” and “ALIEN” were specified, the “CAGNEY” search word might find movies in which James Cagney performed in, as well as the TV series “Cagney and Lacey.” The “ALIEN” search word might find the movie “Aliens” as well as any program which includes the word “alien” in the description. Partial words work as well.

Entering the desired words is easy using the pop-up keyboard. You can highlight the desired letter using the **▲**, **▼**, **◀**, and **▶** keys. Press **SELECT** to enter the letter. Once the word is entered, choose **OK**.



The WatchWord pop-up keyboard

PROGRAMMING YOUR REMOTE CONTROL

8

You can use the remote control that came with your digital satellite receiver to control other components in your entertainment system. The remote control will control your digital satellite receiver and most brands of TVs brands and VCRs.



The remote control.

Programming the Remote Control

{ XE "Remote control:programming" } There are two ways to program your remote control to match you equipment: code scan and code entry. Code scan can take some time, but it avoids having to refer to this manual to program your remote control. Code entry saves some time but you will need to look up the codes assigned to the devices.

Programming Mode

Keep your remote control aimed at the device you want to control during this process. The remote control will send out the “power” command for the device being programmed.

While holding down the device key (i.e., TV) that you are programming, press the “Mute” key for one full second. Then release the keys. The device key should light and stay lit. If it doesn’t, repeat the process.

Then choose either the code scan or code entry method.

Code Scan

Once you are in programming mode, repeatedly tap the **0** key to step through the codes, sending out the power command. This could take some time since there are could be many for each type of device. When your device shuts off, you have found the code. If you inadvertently go past a code that responded, or realized that you may not have been aiming the remote at the device, you can use the **0** key to step backward through the codes. Press the **POWER** key to verify that you haven’t missed the code. In order to lock in the code, press the device key again. The remote will remember the code until you reprogram it.

Code Entry

First, look up the device type and brand in the following charts. You will find a list of numbers; one or more of which should operate your device. If there is more than one code, you will need to try each of them to find the one that works best.

Once you are in code entry mode, enter the three-digit code. Press the device key being programmed once again to lock in the entered code. The remote will remember the code until you reprogram it.

DIGITAL SATELLITE SYSTEM OWNER'S MANUAL

Test if the entered code matches your device by pressing the **POWER** key. If the device works, you're all set. Otherwise, repeat the process using the next code for your brand or try the code scan procedure. { XE "Remote control:codes" }

TELEVISION	CODE NUMBER
Admiral	072 081 160 161
A Mark	112 143
Akai	070 146
Amstrad	052
Anam	043 054 056 080 112 131
AOC	070 004 058 112
Audiovox	076 120
Blaupunkt	088
Candle	070 002 003 004
Capehart	058
Cetronic	043
Citizen	070 002 003 004 043 101 103 143
Classic	043
Concerto	004
Contec	043 050 051
Coronado	143
Craig	043 054 191
Crown	043 143
Curtis Mathes	070 101 143 004
CXC	043
Daewoo	076 103 004 016 043 114 120 127 143 128 136 192 044
Daytron	004 143
Dynasty	043
Dynatech	062
Electrohome	024 076 120 143
Emerson	004 005 028 043 047 048 050 051 076 120 143 151 153 154 155 070 096 191
Fisher	007 057
Funai	028 043
Futuretech	043
GE	160 165 161 070 008 009 034 056 073 074 130 155 167 004 145
Goldstar	004 106 110 112 119 127 143 193
Hall Mark	004
Hitachi	011 004 009 010 012 023 075 143 007 072
Infinity	164
JBL	164
JCPenny	070 004 008 009 030 065 101 160 024 143 156
Jensen	013
JVC	038 001 083 034
KEC	043
Kenwood	070 001
Kloss	002 059
KMC	143
KTV	043 143 154 070
Lodgenet	072
Logik	072
Lauxman	004
LXI	007 015 052 081 160
Magnavox	164 059 070 003 004 060 061 063 064 022 094 127 160
Marantz	070 164
Matsui	164
Memorex	004 007 072
Metz	088
MGA	024 070 004 024 028 042
Minerva	088
Mitsubishi	024 004 040 042 028 146
MTC	070 004 062 101
NAD	015 025

TELEVISION	CODE NUMBER
NEC	070 040 016 056 024 130 134 019 004
Nikei	043
Onking	043
Onwa	043
Optonica	019 081
Panasonic	034 080 056 164
Philco	164 070 003 059 060 064 004 056 063 024
Philips	164 093 038 005 059 127 070 003 004
Pioneer	025 070 004 018 023 190
Portland	004 143 065
Proscan	160 161 167 145 065
Proton	004 058 131 143 171 173
Quasar	034 056 080 164
Radio Shack	004 019 043 127 143
RCA	160 161 156 165 065 070 004 023 024 056 074 152 167 145
Realistic	007 019 043 047
Runco	072 130
Sampo	070 004 058
Samsung	101 004 050 089 105 160 127 143 133
Sanyo	007 020 053 057 082
Scott	004 028 043 048 143
Sears	015 030 028 094 004 007 057 082 143 160 167
Sharp	081 004 014 019 022 028 143 029
Siemens	088
Signature	072
Sony	001 085 126 166 079
Soundesign	028 003 004 043
Spectricon	112
SSS	004 043
Supre Macy	002
Sylvania	070 003 059 060 063 064 127 160 164 044
Symphonics	194 052
Tandy	081
Tatung	056 062
Technics	034 080
Techwood	004
Teknika	002 003 004 024 028 043 072 101 143
Telerent	072
Tera	173
Tmk	004
Toshiba	015 030 007 040 062 101
Universal	008 009
Video Concepts	146
Vidtech	004
Wards	004 019 064 008 009 028 060 061 063 072 074 143 164 165
Westing House	076 120
Yamaha	070 004
York	004
Yupiteru	043
Zenith	072 073 095 103
Zonda	112

VCR	CODE NUMBER
Aiwa	034
Akai	016 043 046 124 125 142

VCR	CODE NUMBER
	146
Ampro	072
Anam	031
Audio Dynamics	012 023 039 043
Brooksonic	035 037 044 129 152
Canon	028 031
Capehart	108
Craig	003 040 135
Curtis Mathes	031 041 156
Deawoo	117 119 005 116 007 010 065 108 110 112
Daytron	108
Dimensia	156
DBX	012 023 039 043
Dynatech	034 053
Electrohome	059
Emerson	006 029 035 025 027 034 036 037 046 101 129 131 138 017 031 044 152 157 153
Fisher	003 008 009 010
Funai	034
GE	031 072 144 147 063 151 107 109 156 126
Go Video	040 132 136
Goldstar	101 123 012 013 114
Harman Kardon	012 045
Hitachi	004 026 034 063 137 150 156
Instantreplay	031
JCL	031
JCPenny	012 013 040 101 156 066
Jensen	043
JVC	048 050 043 130 060 012 031 150 055 158
Kenwood	014 034 047 048 023
Lloyd	034
LXI	034 003 009 017
Magin	040
Magnavox	067 031 034 041 068 154 160 064
Marantz	067 069 031 067 012 023
Marta	101
Matsui	027 030
MEI	031
Memorex	102 101 003 010 014 031 034 053 072 139 134
MGA	045 046 059
Minolta	013 156
Mitsubishi	059 061 046 051 142 013 045 162
MTC	034 040
Multitech	024 034
NEC	012 023 043 048 039
Nordmende	043
Optonica	053 054
Panasonic	070 133 031 066 161
Pentax	013 031 063 156
Philco	031 034 067
Philips	031 067 034 101 054 071
Pilot	101
Pioneer	021 013 048
Portland	108
Quartz	002 014
Quasar	070 133 161 031 066
Radio Shack	123
RCA	107 109 144 147 151 013 041 034 040 156 031 140
Realistic	003 008 010 014 031 034

PROGRAMMING YOUR REMOTE CONTROL

VCR	CODE NUMBER
Rico	040 053 054 101
Salora	058 078
Samsung	014
Sansui	102 040 032 104 107 109 112 113 115 120 122 125 159
Sanyo	043 048 135 022
Scott	003 010 102 007 014 134 017 037 044 129 131 112 159
Sears	003 008 009 010 013 014 017 081 101
Sharp	031 054 053
Shintom	024
Signature	034
Sony	056 057 058 003 052 149 031 155
Soundesign	034
STS	013
Sylvania	031 059 034 067
Symphonic	034
Tandy	010 034
Tatung	039 043 023
Teac	034 039 043 023
Technics	031 070
Teknika	031 019 034 101
TMK	006
Toshiba	112 008 131 047 059 082 013 042
Totevision	040 101
Unitech	040
Vector Research	012
Video Concepts	012 046 034 141
Videosonic	040
Wards	003 013 024 031 034 040 053 054 017 131
Yamaha	012 043 034 039
Zenith	072 080 056 048 034 101 058

Aux	CODE NUMBER
Audio Access	095
Adcom	146 149 227 244
Amc	082 083 084

Aux	CODE NUMBER
Arcam	100
Audio File	093 098
Audio Technica	221
Aiwa	111 114 117 156 170 199 203 219 231 241 254
Akal	181 233
Anam	180
Bose	064 137 219
B & K	150 152
Carver	013 091 098 107 126 129 160 163 164 220 245 249
Casio	076
Clarion	151 169
Denon	101 133 191 202 208 246 247
Enlightened Audio	078 153
Fisher	107 129 157 163 176
Fosgate	113 228 248
Audionics	
GE	216 123
Goldstar	110
Harman Kardon	073 195 248 249
Haital	119
Hitachi	088
JCPenny	109 154 178
Jesen	099
Jerrold	141
JVC	112 198 252
Kenwood	096 104 119 125 148 151 163 171 173 242
Krell	223
Lexicon	215 250
Luxman	066 071 120 134 205 206 229
LXI	123 177
Magnavox	126 162 185 186 224 228
Marantz	074 091 105 126 128 139 155 162 164 186 232
McIntosh	251
Mondial	069 070 077 225 226
MCS	108 178
Mitsubishi	253
Meridian	013 067
NAD	128

Aux	CODE NUMBER
Nakamichi	072 212 234 235
Niles	236
Onkyo	079 094 115 116 207 209 211 255
Optimus	121 125 140 181
Panasonic	131 144 187 200
Parasound	085 086 090
Philips	136 186 126 197
Pioneer	087 093 132 138 210 165 168 189 195 201 081 230
Quasar	131 187
RCA	109 213 166
Realistic	103 122 123 124 172 174 177 179 180 194
Rotel	204 218 239
Sansui	196 214 126 139 075 197
Sanyo	157 129
Samsung	068
Scientific	142
Atlanta	
Scott	180 190
Sharp	096 125 151 161 169 182 193
Sherwood	089 127
Sony	097 117 147 183 200 253 237 238 188 192 080 063 243
Soundesign	135
Soundstream	197
SSI	130
Starcom	141
Symphonic	124
3M	217
Teac	102 159 180 062
Technics	131 143 184 145 187 200 202 208 165
Toshiba	175
Wards	163
Yamaha	092 120 166 240 125 169 065 216
Zenith	222 061

Using the Remote Control

{ XE "Remote control" } Once your codes are entered, you are ready to start using your universal remote control. The device keys allow you to switch from one device to another. Some keys behave in a special way. They control one device while you are actually in another device mode. For instance, while in SATellite mode, pressing Volume +/- controls your TV's volume—not a digital satellite receiver volume. This is because the remote control knows that there is no volume control on the digital satellite receiver.

Advanced feature keys (i.e. **ACTION**, **EXIT**) are not supported for devices other than your digital satellite receiver. For other devices, only the primary keys (i.e. **TV** and **VCR**, **POWER**) will function.

- For Sony-brand devices, use the **ALPHA** key as the "Enter" key.
- For RCA-brand devices, the device key (i.e., "TV" or "VCR") might be the "power on" key and **POWER** is the power off key.

Switching the Remote Control to Operate Additional Digital Satellite Receiver

Your remote control can be reprogrammed to operate additional digital satellite receivers. This may be necessary in situations where multiple digital satellite receivers are located in the same general area and can pick up signals intended for each other.

To switch the remote control, simply press and hold the  key while entering the receiver ID. The receiver ID can be 001 through 004. Do not forget the two zeros. Remember to access the **ADVANCED PREFERENCES** screen using the keys on the front of the digital satellite receiver to pair it with the remote control.

Identifying Codes that Have Been Stored

You can determine the codes that are stored in your remote control. This may be useful for reprogramming additional remote controls later on.

1. Press the device key and the “Mute” key simultaneously.
2. Press the  key and count the number of times the red light on the top of the remote control blinks. Each digit of the three-digit code is separated by a 3-second period the light is off. For example, if the code number is 021, the light will blink 10 times (for “0”), pause three seconds, blink twice, pause three seconds, and blink once.

Controlling Other Components Using the AUX Button

Some additional features are available when the remote control is in the AUX mode. These instructions apply exclusively to the universal remote control (HRMC-3).

Volume Control in AUX Mode

Note that when the remote control is in TV, VCR, or SAT mode, the volume keys control the sound volume for the television. When you're in AUX mode, if your auxiliary component has audio output, the volume keys control that component's sound volume. If your auxiliary component doesn't have audio output, you can program the volume button so that it continues to control the TV volume when your remote control is in AUX mode:

1. Press the “AUX” key and the “Mute” key simultaneously.
2. Press the “Volume Up” key.

Once you perform these steps, whenever your remote control is in AUX mode the volume keys will control the television volume. In the event that you reprogram the “AUX” key to control a different component at some future time, you can restore the remote control's capability to control the auxiliary component's volume by simply repeating these two steps.

VCR Function in AUX Mode

The VCR function keys (Play, Rew, FF, Stop, Pause, and Rec) on the remote control perform those VCR functions when the remote control is in TV and DIRECTV System, as well as VCR, mode. However, if you program the AUX key to control a component that does not need or use these functions, you can program the remote control to maintain VCR functionality in AUX mode.

1. Press the “AUX” key and the “Mute” key simultaneously.
2. Press the “Volume Down” key.

Once you perform these steps, whenever your remote control is in AUX mode the VCR function keys will continue to control the VCR. In the event that you reprogram the AUX key to control a different component that need use of the keys, simply repeat these two steps.

Assigning a Device to a Different Device Key

You can assign a component to a mode key that has a different label. For example, you can assign a second TV to the AUX key.

1. Begin the programming process as described earlier. (i.e. Press “TV” and “Mute” keys simultaneously or “VCR” and “Mute” keys simultaneously.)
2. Once you have established the correct code, either by scanning or direct code entry, *do not* press the device key to lock in your code.
3. Press the “AUX” key to store the code onto the “AUX” key

QUESTIONS AND ANSWERS

APPENDIX

A

Questions? Did we forget to tell you something? Many people, over time, have questions about their DIRECTV System. We have compiled the most common of these questions and the answers in this appendix. We hope they help!

Q { XE "Troubleshooting" } I had a signal but now I am getting a message "Searching for satellite signal. To access related utilities, press **SELECT**." What happened?

A Rain clouds and snow can affect the satellite signal reception. This loss of signal is temporary. Also check for new growth on trees and bushes that could be blocking the signal. One other possibility is that the wind or someone has moved the satellite dish antenna.

Q Why can't I control my TV?

A Before you can control your TV, VCR, or any other device, besides your digital satellite receiver, you must program your remote control to match your different devices. See the chapter, "Programming Your Remote Control" in this manual for specific instructions. If you have already successfully programmed your remote control, try pressing the appropriate device key to put your remote in the proper mode. Then try controlling that device. Also, make sure that the batteries in the remote control are good.

Q My digital satellite receiver does not respond when I press keys. What's wrong?

A Most likely, if the front panel keys work but the remote control doesn't work, try pressing the "SAT" key before trying to control the digital satellite receiver. If that doesn't work, press the "SAT" and "Mute" keys together and try again. If that doesn't work, or if the front panel keys don't work either, unplug your digital satellite receiver for 30 seconds, then plug it back in. Since your digital satellite receiver is a computing device it is susceptible to erratic changes in power and/or signal, just as any other computer, and these sudden changes can cause it to become "confused."

Q Some channels look good, while others freeze or indicate that no signal is available. What's wrong?

A The most common causes for this behavior relate to the cable between your digital satellite receiver and the satellite dish antenna. Confirm that RG-6 (not RG-59) cable is used and does not exceed 100 feet in length. Longer cable runs require amplification. This special amplifier is available from your dealer.

Q How can I watch one satellite program while recording another?

A With only one digital satellite receiver, unfortunately, you can't. Each receiver can only decode one channel at a time.

Q I'm getting a message to call some extension. Why?

A There are many different reasons for this. If you want to watch the channel that is displaying the message, call the service provider for assistance. For channels below 900, call DIRECTV at 1-800-DIRECTV (347-3288). For channels in the 900s, call USSB at 1-800-204-USSB (8772).

Q Why don't I have an on-screen offer to purchase pay per view programs?

A There are three possibilities; your digital satellite receiver must be connected to a phone line and it is not, or your service provider doesn't realize that your phone line is connected, or your service provider has disabled your ability to make on-screen purchases. Call your service provider, at either 1-800-DIRECTV (347-3288) or 1-800-204-USSB (8772), for assistance.

Q Can I receive my local TV programs through my digital satellite receiver?

A To receive local programming you will need either a traditional antenna (i.e. roof mounted, attic mounted or rabbit ears) or "lifeline" cable TV. Connect this signal to the IN FROM ANTENNA on the back of your digital satellite receiver. Use the **INPUT** key to switch between satellite programming and local programming provided on the OUT TO TV connector.

Q If I have questions about my DIRECTV System or need to have it serviced, who should I call?

A For issues regarding your equipment, contact us directly at 1-800-274-8995. If you would like, call your dealer first. They are most familiar with your installation and needs. Also, they are likely to be local to you.

If you need assistance with your subscription, such as adding channels, contact the service provider. For channels below 900, call DIRECTV at 1-800-DIRECTV (347-3288). For channels in the 900s, call USSB at 1-800-204-USSB (8772).

Q I think I set an event to record on my VCR, but when I played the tape back nothing was there. What could be wrong?

A There are several possible reasons for this. First, check that the VCR was programmed correctly and left turned off and the input matches the output from your digital satellite receiver. Confirm that you were authorized to tape the chosen program.

Q I picked up my telephone and it was making a hissing and squealing sound. Why?

A Your digital satellite receiver was reporting any pay per view activity that may have occurred to the service providers. This happens very rarely and lasts for only a minute or so.

Q What if my question isn't listed here?

A Call your dealer or the Customer Care Center at 1-800-274-8995. We will do our very best to answer your questions.

LIMITED WARRANTY

Hughes Network Systems (HNS) provides the following limited warranty on your DIRECTV System from Hughes Network Systems.

This limited warranty is in lieu of all other warranties, whether express, implied, or statutory, including, without limitation, the implied warranties of merchantability and fitness for a particular purpose. HNS shall not be liable for damages in excess of the purchase price of the product less reasonable amount for use and wear, or for any incidental, special, punitive, or consequential damages of any nature whatsoever, or for any delays, loss of use, time, profits, revenue or savings, any commercial loss, inconvenience, damage to buyer's or to other person's property, arising from the use or inability to use the product, or otherwise for any failure to perform. HNS neither assumes nor authorizes any customer care center or any other person or entity to assume any other obligation or liability beyond that which is provided for in this limited warranty. No oral or written information or advice given by HNS, its dealers, distributors, agents or employees, shall create a warranty or in any way increase the scope of this warranty.

Some states do not allow the exclusion or limitation of incidental or consequential damages, or limitations of implied warranties, so the above limitations or exclusions may not apply to Purchaser.

This Limited Warranty gives specific legal rights to Purchaser, and Purchaser also may have other rights which may vary from state to state.

PROVISIONS

Your HNS DIRECTV System equipment (the satellite dish antenna, the digital satellite receiver, and the remote control) is warranted against defects in materials/workmanship for parts and labor:

The digital satellite receiver and satellite dish antenna (including the LNB) are warranted for one (1) year from date of purchase.

The remote control is warranted for ninety (90) days from date of purchase.

This limited warranty does not cover:

- a unit that has been modified
- damage from misuse, negligence, or accident
- any installation, or damages caused by installation
- shipments to HNS that are damaged in transit
- removal and reinstallation of equipment for repair
- loss of programming
- damage due to lightning (for example, power surges, nearby strikes)
- acts of God
- cost of shipping to HNS
- batteries or cables after installation

This limited warranty is not transferable and is valid only in the United States

SERVICE

If you have any questions or encounter any problems, you may contact your authorized HNS dealer or call our Customer Care Center, at 1-800-274-8995. To ensure prompt and efficient service, please have your model and serial numbers handy. Space to note these numbers is provided inside the front cover of this manual. In the event of repair or replacement, you will need these numbers, along with your bill of sale.

RETURN PROCEDURES

In the event that your equipment must be repaired or replaced, you can:

- contact your authorized HNS dealer or call our Customer Care Center to find the authorized service center nearest you.
OR
- choose the "replace after receipt" option, whereby you must ship HNS your defective equipment and, once your unit is received, a new or refurbished unit (at the sole discretion of HNS) will be shipped to you.
OR
- choose the "advance replacement" option, whereby a new or refurbished unit (at the sole discretion of HNS) will be shipped to you after you have provided an accepted credit card number for collateral purposes. Once you receive the replacement part from HNS, return your defective equipment within the specified time period to avoid being charged for the advanced part.

If the warranty on the equipment has expired, the Customer Care technician will provide you with an estimate of the cost to replace the unit when the RMA is assigned.

PACKING INSTRUCTIONS FOR EQUIPMENT TO BE RETURNED

1. Call the Customer Care Center. The Customer Care technician will give you an RMA (Return Merchandise Authorization) and a mailing address for returning your unit.
 2. If you are returning the digital satellite receiver, *please keep your access card and return only the digital satellite receiver.*
 3. Pack the unit in the original box and packing material, if possible, or in other packaging that provides adequate protection for shipping. Include your name and address, the model number, the serial number, and a copy of the bill of sale.
 4. Write: "Attention: RMA #" (the number given to you by the Customer Care technician) on the return shipping label.
 5. Insure the shipment for the full replacement value.
-

If the warranty on the equipment has expired, the Customer Care technician will provide you with an estimate of the cost to replace the unit when the RMA is assigned.

HUGHES

NETWORK SYSTEMS

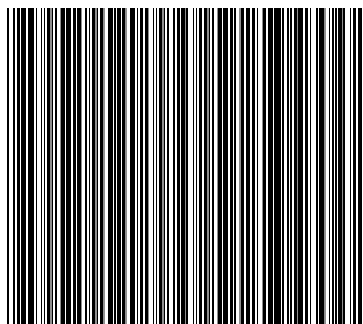

Part # 1026627-0002 (Revision: B)



This document was printed in the U.S.A. on recycled paper.